

ISOMAG 2.0

T. Blochwitz, S. Bittner, U. Schreiber, A. Uhlig

**Research
Project F 2311**

T. Blochwitz
S. Bittner
U. Schreiber
A. Uhlig

ISOMAG 2.0

**Software for Optimal Vibration Isolation
of Machines and Devices**

Dortmund/Berlin/Dresden 2013

This publication is the final report of the project 'ISOMAG 1.3 - Ergänzungen und Änderungen' – Project F 2311 – on behalf of the Federal Institute for Occupational Safety and Health.

The responsibility for the contents of this publication lies with the authors.

Authors: Dipl.-Ing. Torsten Blochwitz
M. Sc. Stefan Bittner
Dipl.-Ing. Uwe Schreiber
Dr. Andreas Uhlig
ITI Gesellschaft für ingenieurtechnische
Informationsverarbeitung mbH
Schweriner Straße 1, 01067 Dresden, Germany
Telephone +49 351 26050-0
Fax +49 351 26050-155
info@iti.de
www.iti.de

Cover image: Federal Institute for Occupational Safety and Health (BAuA)

Cover design: Rainer Klemm
Federal Institute for Occupational Safety and Health (BAuA)

Publisher: Federal Institute for Occupational Safety and Health (BAuA)
Friedrich-Henkel-Weg 1-25, 44149 Dortmund, Germany
Telephone +49 231 9071-0
Fax +49 231 9071-2454
poststelle@buaa.bund.de
www.buaa.de

Berlin:
Nöldnerstr. 40-42, 10317 Berlin, Germany
Telephone +49 30 51548-0
Fax +49 30 51548-4170

Dresden:
Fabricestr. 8, 01099 Dresden, Germany
Telephone +49 351 5639-50
Fax +49 351 5639-5210



All rights reserved, including photomechanical reproduction and the reprinting of extracts.

www.buaa.de/dok/4415106

Remarks of the Publisher

Licence provisions

The program enclosed contains a single licence for one workstation. A program with a single licence must not be used in a network.

All parts of the documentation, the data and the software are subject to copyright. All rights are protected. Any duplication or propagation in whole or in part is prohibited. No part of the documentation or software must be copied, transmitted photographically, reproduced, translated, stored on another electronic medium or converted to a machine-readable form.

The database isobank.mdb installed with the program is expressly exempted from copyright and the modification prohibition. This database contains data for vibration insulators according to information from the manufacturers. It may be modified and/or supplemented by any user at own risk. The database may only be published or passed on to third parties with the express, written permission of the publisher.

Warranty

All data, information, technical details and programs have been compiled conscientiously and tested with the utmost care. Despite this, however, it is not possible to give any warranty for absolute freedom from error or for the correctness of the contents.

No liability shall be accepted for technical faults, problems and erroneous data or for the consequences of such. It is therefore pointed out that any and all claims for compensation are hereby excluded. This concerns in particular the use of the insulator database isobank.sdf (see also next page). If the user changes the database isobank.mdb no warranty shall be given that proper working with the program ISOMAG will be possible.

For actual information about the program and updated versions of the insulator database please contact our website www.baua.de/isomag.

Database isobank.sdf - Instructions for Use and Exclusion of Warranty -

The database isobank.sdf installed with the program ISOMAG contains a total of over 3500 insulators from 20 European manufacturers. There is a list of the manufacturers in \ISOMAG\Documents\Herstell.xls. In spite of the efforts of the Federal Institute for Occupational Safety and Health - BAuA – to ensure that this list is complete, not all insulator manufacturers are represented. The database does not contain the complete production range of the manufacturers given. The database does not contain details of special features of the insulator selected (e.g. oil resistance, risk of soiling etc.).

It is expressly stated that if data is included in the database this does not imply any evaluation with respect to the quality of the products or any recommendation to buy. The data is not subject to an update service or any monitoring by the manufacturer.

In spite of the great care that has been exercised in handling the data, the possibility cannot be discounted that errors have been made in taking over or processing data. The publisher gives no guarantee that the program and the content of the database are correct. Where a third-party claim for compensation arises from their use, neither the publisher nor the manufacturers shall be liable in any way.

It is recommended that, after he/she has selected a certain vibration insulator, the user contact the manufacturer directly or a sales office to verify the parameters or suitability for specific ambient conditions. This applies especially when setting up with natural frequencies below 10 Hz and in the case of heavy duty insulators. Contacts are given in the file Herstell.xls (Herstell.pdf).

The publisher and the authors would be grateful for any suggestions for improvements and any indication of errors. The person to contact in the publisher's office is:

Federal Institute for Occupational Safety and Health (BAuA)
Friedrich-Henkel-Weg 1–25, D-44149 Dortmund
Phone +49 231 9071-2071
Fax +49 231 9071-2070
Info-zentrum@baua.bund.de

Contents

	Page
Abstract	8
Kurzreferat	9
1 Introduction	10
1.1 Reason of the task and target of the research project	10
1.2 New in ISOMAG 1.0 .. 1.2	10
1.3 New in ISOMAG 2.0	11
1.4 Classification of the vibration isolation into the protection against vibration	12
1.5 Bibliographical evaluation/searches	13
2 Theoretical basis of the vibration isolation	14
2.1 Minimum model of the one-mass oscillator	15
2.1.1 Formulas of the force-excited oscillator	16
2.1.2 Equations of the ground-excited oscillator	17
2.1.3 Transmissibility and degree of isolation	18
2.2 Minimum model of the two-mass oscillator	19
2.2.1 Natural frequencies of the two-mass oscillator	20
2.3 Transmissibility and degree of isolation of the two-mass oscillator	22
2.4 The block foundation - The oscillator with 6 degrees of freedom	25
2.5 Double vibration isolation – The oscillator with 12 degrees of freedom	27
2.6 Consideration of the dynamic characteristics of the installation place – the oscillator with 13 degrees of freedom	28
2.6.1 Bases of the consideration of the installation place	28
2.6.1.1 Virtual parameters for the beam hinged on both ends	29
2.6.1.2 Virtual parameters for a clamped beam	31
2.6.1.3 Virtual parameters for the rectangular plate hinged on all sides	32
2.6.1.4 Virtual parameters for the all-side clamped rectangular plate	34
2.6.1.5 Virtual parameters for a clamped and hinged rectangular plate	35
2.6.2 Structure of the complete model	35
2.7 Conversion of continuously distributed stiffness to discrete parameters	36
2.7.1 One dimensional stiffnesses	36
2.7.2 Grounds	39
3 Bases of the program ISOMAG	42
3.1 Algorithms	42
3.1.1 Coordinate systems	42
3.1.1.1 Global coordinate system (GCS)	42
3.1.1.2 Coordinate system of machine (MCS) and foundation coordinate system (FCS)	42
3.1.1.3 Center of gravity coordinate system (CCS)	43
3.1.1.4 Coordinate system of inertia principal axis (PICS)	43
3.1.1.5 Principal coordinate system (PCS)	43

3.1.1.6	Element coordinate system (ECS)	43
3.1.1.7	Reference coordinate system (RCS)	44
3.1.2	Coordinate transformations	44
3.1.3	Calculation of the inertia properties	47
3.1.3.1	Calculation of the element mass matrices	48
3.1.3.2	The mass matrix in centers of gravity coordinates (CCS)	48
3.1.3.3	Calculation of principal axes of inertia	49
3.1.4	Calculation of the stiffness properties	50
3.1.4.1	General remarks on the stiffness matrices	50
3.1.4.2	The stiffness matrix for the static calculation	52
3.1.4.3	If the matrix cannot be inverted...	52
3.1.4.4	Calculation of the principal translatory stiffnesses and axes	52
3.1.4.5	Calculation of the center of elasticity	54
3.1.4.6	The stiffness matrix for the dynamic calculation	54
3.1.5	Static Calculation	54
3.1.6	Natural frequencies and vibration modes	55
3.1.7	Transformation to principal coordinates	55
3.1.8	Consideration of the damping	57
3.1.9	Frequency response functions	58
3.1.9.1	Force excitation	58
3.1.9.2	Ground excitation	60
3.1.9.3	Imbalance excitation	61
3.1.10	Transmissibility	61
3.1.11	Time solutions	61
3.1.11.1	Time solutions for non-harmonic excitation	61
3.1.11.2	Time solutions for harmonic excitation	63
3.1.11.3	Imbalance	64
3.1.12	Dimensioning calculation	64
3.1.12.1	Calculation of the required stiffness for the simple vibration isolation	64
3.1.12.2	Stiffness and mass of foundation for the double vibration isolation	66
3.2	Database connection	67
3.2.1	Target and request	67
3.2.2	Database structure	67
4	Program description	69
4.1	Hard and software requirements	69
4.2	Scope and field of application	69
4.2.1	Limitations	71
4.2.1.1	Springs with non-linear force/displacement curve	71
4.2.1.2	Large Distorsion	72
4.2.1.3	Pulses and other non-periodic excitations	73
4.3	General operational sequence	73
4.4	The graphical user interface	75
4.4.1	Worksheet	76
4.4.2	Object bar	76
4.4.3	Tree view	79
4.4.4	Menu Bar	79
4.4.4.1	File menu	79
4.4.4.2	Edit menu	79
4.4.4.3	Calculation menu	80

4.4.4.4	Results menu	81
4.4.4.5	View menu	81
4.4.4.6	Extra menu	81
4.4.4.7	Window menu	83
4.4.5	Toolbar	83
4.4.6	Status Bar	83
4.5	The construction of models	84
4.5.1	Creation of objects	84
4.5.2	Selecting objects	85
4.5.2.1	Selecting objects in one of the model views	85
4.5.2.2	Selecting objects in the tree view	86
4.5.3	Properties of objects	86
4.5.3.1	General properties	86
4.5.3.2	Position	87
4.5.3.3	Dimensions	87
4.5.3.4	Synchronous parameter input of multiple objects	88
4.5.4	Manipulation of objects	89
4.5.4.1	Moving objects	89
4.5.4.2	Rotation	89
4.5.4.3	Changing measures	89
4.5.4.4	Label	90
4.5.5	Deleting objects	90
4.5.6	Copy, cut, paste and duplicate objects	90
4.5.7	Undo and redo of manipulations	91
4.6	Object description	91
4.6.1	Machine and foundation	91
4.6.2	Body	91
4.6.3	Advanced bodies	93
4.6.3.1	Free Prism	93
4.6.3.2	CAD Import	94
4.6.4	Isolators	96
4.6.4.1	Arrangement	96
4.6.4.2	General parameter dialog	97
4.6.4.3	Parameter dialog "Stiffness"	98
4.6.4.4	Parameter dialog for the description of the damping	98
4.6.4.5	Parameter dialog for limit values	99
4.6.5	Isolator table	100
4.6.6	Environment	101
4.6.7	Excitation	102
4.6.7.1	Excitation caused by Earthquakes	104
4.6.7.2	Imbalance	104
4.6.8	Points	105
4.7	Calculation	105
4.7.1	Settings	106
4.7.2	Dimensioning calculation	107
4.7.2.1	Wizard for Single Vibration Isolation	108
4.7.2.2	Wizard for Double Vibration Isolation	109
4.8	Results	112
4.8.1	Static results	113
4.8.1.1	Principal moments of inertia	113

4.8.1.2	Principal stiffnesses	113
4.8.1.3	Static determinateness and compliance with static limit values	114
4.8.1.4	Static displacements and loads	114
4.8.1.5	Natural frequencies and natural modes	116
4.8.2	Dynamic results RCS	116
4.8.2.1	Representation over the time	116
4.8.2.2	Representation over the frequency	118
4.8.3	Freezing result curves	120
4.8.4	Animation	120
4.8.5	Video Export	121
4.9	Documentation	122
4.10	Useful notes/Troubleshooting	123
5	Special program modules	125
5.1	Database selection of isolators	125
5.2	Characteristic curves of the force displacement	127
5.3	Result windows	131
5.3.1	Menus und toolbar buttons	132
5.3.1.1	File menu	132
5.3.1.2	Edit menu	133
5.3.1.3	Options menu	133
5.3.2	Curve	134
5.3.2.1	Window properties	134
5.3.2.2	Properties of the axes	135
5.3.2.3	Properties of the curve display	137
5.3.3	Further functions	138
5.3.3.1	Current result	138
5.3.3.2	Rename gradients and curves	139
5.3.3.3	Modifying Units	139
5.3.3.4	Value display	139
5.3.3.5	Zoom	141
5.3.3.6	Drag&Drop of results	142
5.4	Print Designer	142
5.4.1	Outline	143
5.4.1.1	Document organization and the Explorer	144
5.4.2	Object types and their manipulation	145
5.4.2.1	Graphics	145
5.4.2.2	Parameters	145
5.4.2.3	Tables	145
5.4.2.4	Texts	145
5.4.2.5	Others	146
5.4.3	Object properties	146
5.4.4	Handling	147
5.4.4.1	Moving objects	147
5.4.4.2	Scaling objects	147
5.4.4.3	Browse and Zoom	148
5.4.4.4	Select area	148
5.4.4.5	Format	148
5.4.4.6	Others	149
5.4.5	An individual template	150

6	Bibliography	151
7	Appendix	158
7.1	Syntax for alphanumeric inputs	158
7.1.1	Explanations concerning the notation	158
7.1.2	Mathematical expressions	158
7.1.3	Examples	159
7.2	Figures	161
7.3	Tables	168
7.3.1	Inertia of the elementary bodies	168
7.3.2	Menus	169
7.3.3	Toolbar buttons	172
7.4	Examples	174
7.4.1	Example Centrifuge.isg	174
7.4.2	Example Fan.isg	181
7.4.3	Example Fan2.isg	184
7.4.4	Example Ground.isg	186

ISOMAG 2.0 – Software for Optimal Vibration Isolation of Machines and Devices

Abstract

Vibrations emanating from machines can be detrimental to human health and well-being. Aside from that, vibrations increase safety hazards in machinery, buildings and installations. The primary goals of vibration isolation are to restrict the effects of vibrations on people to within reasonable limits and to protect sensitive apparatus and safety systems from becoming overloaded or suffering damage or breakdown caused by excessive stress from vibrations.

Software **ISOMAG**, a further development of **ITI-ISO** (Fb 769) was created in research plan. Graphics and operation were improved considerably. Besides the single vibration isolation, interpretation and calculation of double one as well as consideration of dynamic properties of the position are now also possible. The main purpose of the program is to design and optimize vibration isolation in machine and apparatus setups (secondary vibration protection).

Interactive graphics are used in the program operation, model description, and data input and output. Linkage to a database permits rapid and certain acceptance of the characteristic quantities of the vibration isolators. The program supports the user in making a suitable selection and arrangement of vibration isolators. It calculates the quantities that are relevant for the evaluation – quantities such as characteristic frequencies; forces; mode shapes, velocities and accelerations; as well as transmissibilities. It also monitors the observance of limit values. The user receives meaningful results with the lowest possible expenditure of preparatory work and model description.

Key words:

single and double vibration isolation, isolation in machines and apparatus setups, block foundation, rigid machine, elastically supported rigid body

ISOMAG 2.0 – Software für optimale Schwingungs- isolierung von Maschinen und Geräten

Kurzreferat

Von Maschinen ausgehende Schwingungen können sich negativ auf Gesundheit und Wohlbefinden von Menschen auswirken. Außerdem stellen Schwingungen für Geräte, Gebäude und Anlagen ein erhöhtes Sicherheitsrisiko dar. Die Wirkung von Schwingungen auf den Menschen in vertretbaren Grenzen zu halten sowie empfindliche Geräte und sicherheitstechnische Anlagen vor Überlastung bzw. Schäden oder Ausfall infolge zu hoher Schwingungsbeanspruchungen zu schützen, sind wichtige Aufgaben der Schwingungsisolierung.

Im Forschungsvorhaben entstand die Software **ISOMAG**, eine Weiterentwicklung von **ITI-ISO** (Fb 769). Grafik und Bedienkomfort wurden wesentlich verbessert. Neben der einfachen sind jetzt auch Auslegung und Nachrechnung der doppelten Schwingungsisolierung sowie die Berücksichtigung der dynamischen Eigenschaften des Aufstellorts möglich. Hauptanwendungsgebiet des Programms sind Auslegung und Optimierung der schwingungs isolierten Aufstellung von Maschinen und Geräten (sekundärer Schwingungsschutz).

Die Programmbedienung, Modellbeschreibung sowie die Datenein- und -ausgabe erfolgen grafisch interaktiv. Eine Datenbankanbindung ermöglicht die schnelle und sichere Übernahme der Kenngrößen der Schwingungsisolatoren. Das Programm unterstützt den Anwender bei der Auswahl und Anordnung von Schwingungsisolatoren. Es berechnet die für die Beurteilung relevanten Größen wie Eigenfrequenzen, Kräfte, Schwingwege, Schwinggeschwindigkeiten und Schwingbeschleunigungen sowie Vergrößerungsfunktionen. Die Einhaltung von Grenzwerten wird überwacht. Der Anwender erhält aussagefähige Ergebnisse, bei geringstem Aufwand bezüglich Einarbeitung und Modellbeschreibung.

Schlagwörter:

einfache und doppelte Schwingungsisolierung, isolierte Aufstellung von Maschinen und Geräten, Blockfundament, starre Maschine, elastisch gestützte starre Körper

1 Introduction

1.1 Reason of the task and target of the research project

On the one hand oscillations can affect health and well-being of people negatively. The reduction of the oscillation exposure for people whose working place is in the neighborhood of machines with high oscillation emission, is therefore of central importance.

On the other hand oscillations for machines, buildings and systems represent an increased safety risk. It is a further important function of the vibration isolation to minimize this risk to protect sensitive devices and safety-relevant systems against overload or faults or failure due to high vibration stresses.

The target of the research project is: to create a user friendly computational program which is executable under MS- Windows. The program serves as a dimensioning and optimization of the vibration isolation of machines and devices (secondary protection against vibration).

To a large extent self-describing operator control and clear handling distinguish the software. The program operation, model description as well as the data in and - output take place graphic-interactively. A database binding enables the rapid and safe transfer of the characteristics of the vibration isolators. Thus the user obtains expressive results - with lowest expenditure on training and model description.

The program supports the user with the selection and arrangement of vibration isolators. It calculates the quantities relevant for the evaluation such as forces, displacements, velocities and accelerations. The observance of limiting values (admissible loads and displacements) is checked. The representation of the achieved isolating effect takes place graphically. All input and result variables can be printed in clear form as diagrams, text or tables.

Function of the current research topic is the advancement of the software, in order to extend its field of application and to improve the control comfort. Thus the available research report represents advancement and a revision of the research report [1]. The following section 1.2 summarizes the focal points.

1.2 New in ISOMAG 1.0 .. 1.2

The program **ISOMAG** is an advancement of the program **ITI**®- **ISO**. With the conversion to the 32-bit-technology benefits become usable like modern tools for model creation, model handling or data exchange, extended operating possibilities, improved diagram, new representation possibilities for models and results as well as more rapid and more stable processing.

Two rigid bodies can be described and considered, when flexibly connected with each other and/or with the environment. Thus the double vibration isolation is calculable. Also for the double vibration isolation a revision and a dimensioning calculation

can be offered. An assistant supports the user with the sizing of the foundation and with the selection of suitable isolators. One can start with the simple vibration isolation and turn later to the double one. Comparative calculations between simple and double vibration isolation are likewise possible.

Also the dynamic characteristics of the environment can be considered in **ISOMAG**. For the installation site of the machine the virtual parameters (mass, frequency and stiffness of for example building ceilings) can be entered or calculated by **ISOMAG**.

The numerical input improved, for example with the position of radial-thrust bearings. Angles of revolution for the description of the position can be entered now in any order.

In one operates **ISOMAG** constantly with physical units. These can be selected and changed for the input and output. If units are modified, a suitable conversion of the values takes place.

For imbalances beside the time solutions also amplitude responses and transmissibilities over the frequency can be calculated now.

The ground excitation can have any direction. For example, bilevel or lateral or horizontal ground excitations can be modeled.

The dimensioning measurement routines for representation and printing are improved too. Thus for example distances can be checked with the model construction or output or printed dimensioned representations, which contain information of position and arrangement of the isolators or of the dimensions of the foundation.

Forces affecting the base as well as the transmissibilities with imbalance were added as result values.

1.3 New in **ISOMAG 2.0**

ISOMAG 2.0 increases the amount of available bodies, eases the usage and ensures the executability under up to date Windows versions (XP, Vista, Windows 7 und 8). The isolator database was converted to the future proof SQL-format.

Using the **CAD import** arbitrary geometries can be imported within **ISOMAG** from STL files. STL is a low level exchange format which is supported by almost every CAD tool in the market. The inertia parameters are computed automatically during import but can be changed manually.

The new **prismatic body** with free cross section allows the modeling of profiles. The inertia parameters are computed automatically as well.

The parameters of all isolators in a model can be edited in the **isolator table** now. The **default values** for new isolators can be given.

The animation of the results (natural mode shapes, vibration shape) was extended. The **animation sequence** can be stored in a **video file** in different formats. Animation speed and cutting can be changed.

The **result windows** and their settings are now **stored** within the **ISOMAG** file

Undo/Redo allows allow reverting and repeating of the 20 last actions.

1.4 Classification of the vibration isolation into the protection against vibration

After [2] one understands by protection against vibration or Oscillation defense all steps, which are suitable, to reduce or eliminate unwanted variable forces or movements. The following diagram arranges the vibration isolation in the protection against vibration:

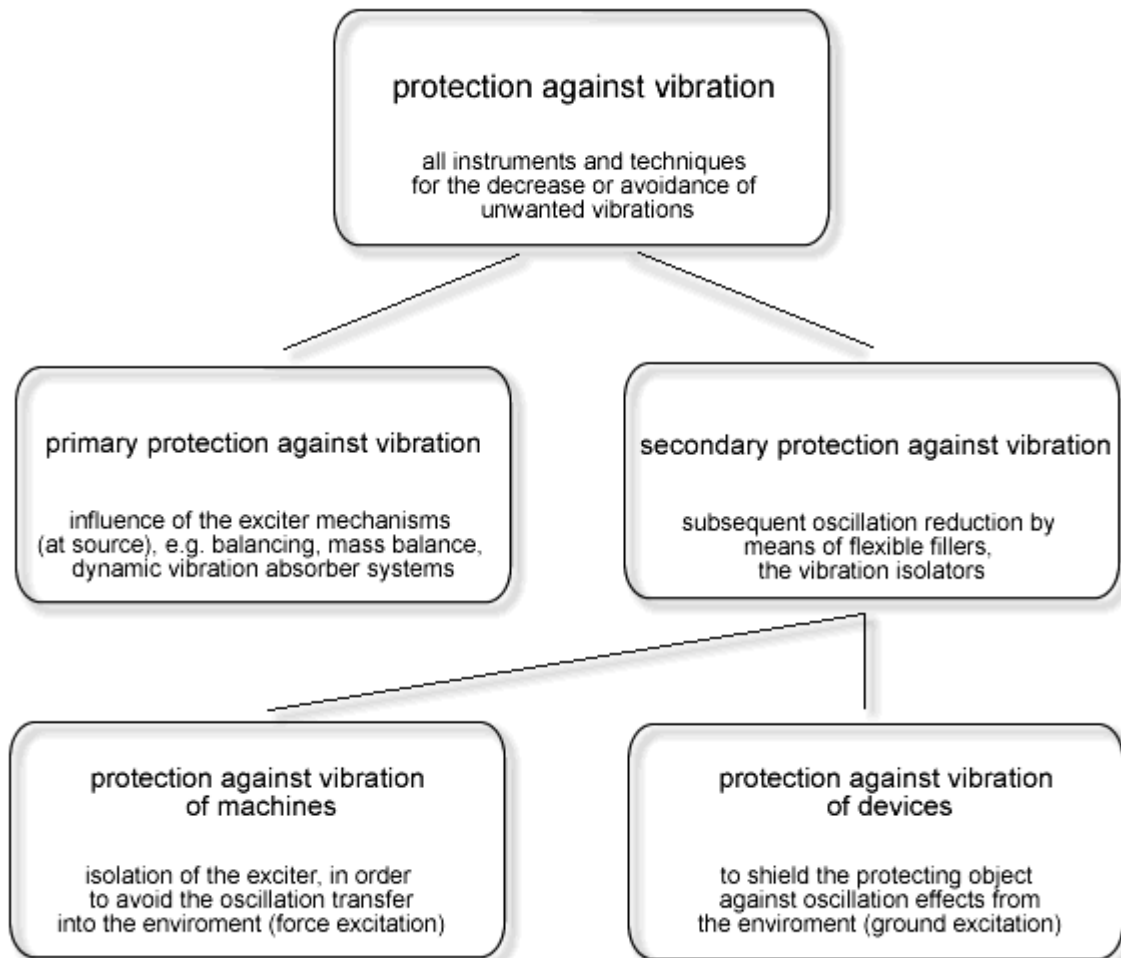

fig. 1.1 Classification of the vibration isolation into the protection against vibration

Target of the vibration isolation is, to protect the object by means of flexible fillers, the isolating items, to a large extent as possible from the exciter. Beside the isolators also additional masses can be used as foundations. One differentiates thereby between vibration isolation of machines and vibration isolation of devices (cf. **fig. 1.1**).

1.5 Bibliographical evaluation/searches

Searches in the apron of ITI[®]- ISO have resulted in no generally accessible software solutions being detectable, which runs on today PCs are available or with the demands made today on modern software becomes fair. The program AUTRA [6] is not offered any longer. But it could be regarded however as orientation for the required scope of calculations.

The functions and targets of the vibration isolation as well as their theoretical bases are well-known and already for a long time subject of scientific investigations and in the literature. Theoretical and practical questions of the machine foundation are treated in detail for example in [7] or [8]. [10] is to be called as global work to the dynamics of even block foundations. Questions of the structure dynamics and approaches for the consideration of the damping are discussed in [11] and [12]. One finds designs to request of software for the linear structural analysis regarding modeling, system structure and resultant representation in [13].

Additionally different standards and guidelines in handling of the topic were analyzed. A global compilation and arrangement of all rules, standards and guidelines which relate to mechanical oscillations in connection represent [14]. In [2] fundamental terms are described such as system, characteristics value, excitation and response. The area of the vibration isolation is defined and differentiated. In [3] and [4] one finds evaluation and standards of valuation. [15] concerns itself with terms and classification of oscillations or oscillation vibration systems. Oscillations are divided regarding their temporal processes and their emergence. The methods of the harmonic analysis and the Fourier transformation as well as the formation of evaluation sizes such as average values or power densities are described. Terms such as system, coordinates, variables of state, eigenvalues, modal matrix or frequency response functions are defined [16]. In [17] finds further definitions like those of the static and dynamic loads, general to concept and calculation as well as approximate values for foundation or location of the machine co-ordination conditions which were aimed. Additionally there is secured, which specification of isolators -as well as machine manufacturers is to be made obligatory for foundation. Finally in the Euro-standard [18] the main points of vibration isolation are compiled. One can regard this standard as summary and specifying the standards and guidelines quoted before.

In order to be able to tie to the present usual methods of the vibration isolation, the catalogues of different manufacturers were analyzed (e. g. [19] to [23]). The analysis of the catalogues took place referencing the parameters indicated for the vibration isolators of the manufacturer as well as concerning the given calculation and selection methods.

2 Theoretical basis of the vibration isolation

In section 1.2 the vibration isolation was arranged in the protection against vibration. Their function consists [2] in the reduction of the transfer of vibration forces by the installation of elastic and if necessary damping components - the isolators. In the machine dynamics the installation of machines belongs to their most important functions [7].

The problems of the setting up of machinery are of interest for manufacturers, project leaders and for operators. The flexibly installed machine is a vibratory system, whose characteristics must be known. By variation of stiffness and inertia properties the natural frequencies of this system can be influenced directly. While the installation elements exert influence on the stiffness, the inertia properties can be influenced by foundations. Thereby a location is aimed at, with only the low (ideally "none") dynamic interaction between installed object and installation site. Both the dynamic forces and the occurring movements are to be held in certain limits.

The dynamic interactions are influenced by suitable tuning of the natural frequencies of the installed object in relation to the exciter frequencies. One differentiates:

- **the deep tuning**, with which the highest natural frequency is smaller than the lowest exciter frequency,
- **the high tuning**, with which the natural frequencies are above the spectrum of the exciter frequencies and
- **the mixed tuning**, with which the spectra of the own and exciter frequencies overlap; however so that no resonance occurs.

In practice all types of tuning are used. Target of the vibration isolation is that the response amplitudes become smaller than the exciter amplitudes. This is possible for the deep and partly for the mixed tuning. For the high tuning and also partially for the mixed tuning the response amplitudes are larger than the exciter amplitudes. If a modification of the type of tuning is not possible, the amplitudes can be reduced only by a larger damping. This is called oscillation damping.

The exact knowledge of the exciter and natural frequencies is, however, in each case a prerequisite for a successful tuning. While usually the excitations are given, the natural frequencies from the stiffness and inertia conditions must be calculated.

In the following the locations of the rigid machine is considered. That means the lowest natural frequency of the object to be installed (possibly including a rigidly coupled foundation) is higher than the highest natural frequency of the flexibly installed object. In this case the complex of machines and foundation can be assumed as rigid. Since a rigid body in the space has 6 degrees of freedom, a model with 6 degrees of freedom results. In this model the minimum model of the oscillator with one degree of freedom, what many manufacturers of isolating items use for their selection (e. g. [20] or [23]) is contained as special case.

If one places the rigid machine flexibly on a foundation mounted flexibly against the environment (further rigid body), then one speaks of the double vibration isolation. The model has then two rigid bodies and has thus 12 degrees of freedom.

Still the dynamic characteristics (mass and stiffness) of the environment or the installation place can additionally be considered. Since generally the consideration is sufficient in the direction of the force of gravity direction, the number of the degrees of freedom increases by one to 13.

2.1 Minimum model of the one-mass oscillator

The oscillator with one degree of freedom is well suited for clarifying questions in principle of the vibration isolation of machines and devices as well as for the preselection of vibration isolators. Additionally the formulas derived from it can be applied, if one transforms models with several degrees of freedom on so called principal coordinates. One receives then instead of a joined set of equations n (decoupled) formulas for one-mass oscillators.

In connection with the vibration isolation there are two minimum models of interest: The force-excited and the ground-excited oscillators with one degree of freedom (**fig. 2.1**). $F(t)$ is the time-dependent force excitation, $s(t)$ is the time-dependent path excitation or ground excitation. The coordinate x describes the movement of the oscillator. Its parameters mass, damping and rigidity are named m , b and c .

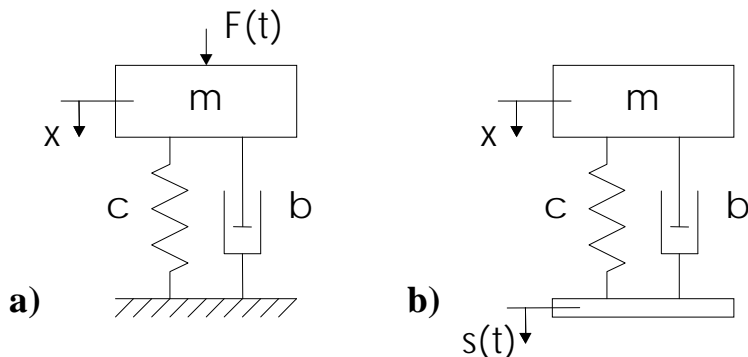

fig. 2.1 Minimum models for the vibration isolation, one-mass oscillator
 a) force excitation for the vibration isolation of machines
 b) ground excitation for the vibration isolation of devices

In order to protect the environment against forces, which emit from the machine, model a) is used). If possible the little force created by the machine is to be conducted over the location into the environment. Model b) is used, if a sensitive device is to be protected against the movements of the environment. The amplitudes of motion of the installed object should be only a fraction of the amplitudes of motion of the installation place. Once the transfer of a force, the other time the transfer of a displacement amplitude is to be reduced. The solution of both problems leads to the same results, so that they can be treated as simultaneous.

2.1.1 Formulas of the force-excited oscillator

The motion equation of the force-excited oscillator with one degree of freedom reads:

$$m\ddot{x} + b\dot{x} + cx = F(t). \quad (2.1)$$

With harmonic excitation for the force F can be written:

$$F = F(t) = \hat{F} \sin(\Omega t). \quad (2.2)$$

\hat{F} being the amplitude of the force, Ω the circular frequency of their temporal change. The solution is simplified if we turn to complex quantities [7]. They are indicated in the following with „ $\tilde{}$ “. With the Euler number e and the imaginary unit j thus

$$F = \hat{F} \cdot e^{j(\Omega t + \varphi)} = \hat{F} \cdot e^{j\varphi} \cdot e^{j(\Omega t)} = \tilde{F} \cdot e^{j\Omega t}. \quad (2.3)$$

The formula (2.2) is contained (2.3) as imaginary part. The introduction of the angle φ enables the consideration as well as the correct according to phase overlay of the result values to different phase status. For the vibration isolation the in-swing or stationary status, with which the oscillation takes place in the exciter frequency, is of interest. Therefore for x a similar approach is selected:

$$x = \tilde{x} \cdot e^{j\Omega t}. \quad (2.4)$$

Twice differentiating of (2.4) by the time

$$\dot{x} = j\Omega \tilde{x} \cdot e^{j\Omega t} = \dot{\tilde{x}} \cdot e^{j\Omega t} \quad (2.5)$$

$$\ddot{x} = -\Omega^2 \tilde{x} \cdot e^{j\Omega t} = \ddot{\tilde{x}} \cdot e^{j\Omega t} \quad (2.6)$$

and using in (2.1) leads to:

$$-m\Omega^2 \tilde{x} e^{j\Omega t} + bj\Omega \tilde{x} e^{j\Omega t} + c\tilde{x} e^{j\Omega t} = \tilde{F} e^{j\Omega t} \text{ or}$$

$$\tilde{x}(c - m\Omega^2 + jb\Omega) = \tilde{F} \quad (2.7)$$

With the abbreviations ω for the natural frequency of the undamped system, η for the frequency ratio and D for the damping ratio

$$\frac{1}{\omega^2} = \frac{m}{c}, \quad \eta = \frac{\Omega}{\omega} \quad \text{and} \quad D = \frac{b}{2\sqrt{cm}} \quad (2.8)$$

one receives after some transformations

$$\tilde{x} = \frac{\tilde{F}}{c} \left[\frac{1 - \eta^2}{(1 - \eta^2)^2 + 4D^2 \eta^2} - j \frac{2D\eta}{(1 - \eta^2)^2 + 4D^2 \eta^2} \right]. \quad (2.9)$$

With $\dot{x} = j\Omega \tilde{x} \cdot e^{j\Omega t}$ results for the velocity:

$$\dot{\tilde{x}} = j\Omega \frac{\tilde{F}}{c} \left[\frac{1 - \eta^2}{(1 - \eta^2)^2 + 4D^2 \eta^2} - j \frac{2D\eta}{(1 - \eta^2)^2 + 4D^2 \eta^2} \right]. \quad (2.10)$$

The looked up force affecting the base F_B is (for equilibrium reasons) equal to the total of the forces in spring and damper:

$$F_B = cx + b\dot{x}, \quad \text{or in complex notation}$$

$$\tilde{F}_B = c\tilde{x} + b\dot{\tilde{x}}. \quad (2.11)$$

A using of the formulas **(2.9)** and **(2.10)** to **(2.11)** and the reference to the excitation finally supply:

$$\frac{\tilde{F}_B}{\tilde{F}} = \left[\frac{1 - \eta^2 + 4D^2 \eta^2}{(1 - \eta^2)^2 + 4D^2 \eta^2} - j \frac{2D\eta^3}{(1 - \eta^2)^2 + 4D^2 \eta^2} \right]. \quad (2.12)$$

If one forms the absolute value the complex quantities **(2.12)** one receives the transmissibility important for the vibration isolation (cf. **section 2.1.3**).

2.1.2 Equations of the ground-excited oscillator

For the ground-excited oscillator the motion equation can be written as follows:

$$m\ddot{x} + b(\dot{x} - \dot{s}) + c(x - s) = 0. \quad (2.13)$$

We used **(2.4)** for x . Similarly for the harmonic excitation s we take:

$$s = \tilde{s} \cdot e^{j\Omega t}. \quad (2.14)$$

Using of **(2.4)** and **(2.14)** and their derivations after the time to **(2.13)** leads to:

$$\tilde{x}(c - \Omega^2 m + jb\Omega) = (c + jb\Omega)\tilde{s}. \quad (2.15)$$

After some transformations and using the abbreviations **(2.8)** for the stationary movement of the oscillator referred to the harmonic excitation yields:

$$\frac{\tilde{x}}{\tilde{s}} = \left[\frac{1 - \eta^2 + 4D^2\eta^2}{(1 - \eta^2)^2 + 4D^2\eta^2} - j \frac{2D\eta^3}{(1 - \eta^2)^2 + 4D^2\eta^2} \right]. \quad (2.16)$$

The right hand side of the formula (2.16) is identical to (2.12). One receives thus for the ground excitation the same transmissibility as for the force excitation (cf. section 2.1.3).

2.1.3 Transmissibility and degree of isolation

If one forms the absolute value of complex quantities (2.12) or (2.16) the transmissibility V is received:

$$V = \frac{\sqrt{1 + 4D^2\eta^2}}{\sqrt{(1 - \eta^2)^2 + 4D^2\eta^2}} \quad (2.17)$$

If one displays the transmissibility V over the frequency ratio η with damping D as parameter, the following, well-known representation results:

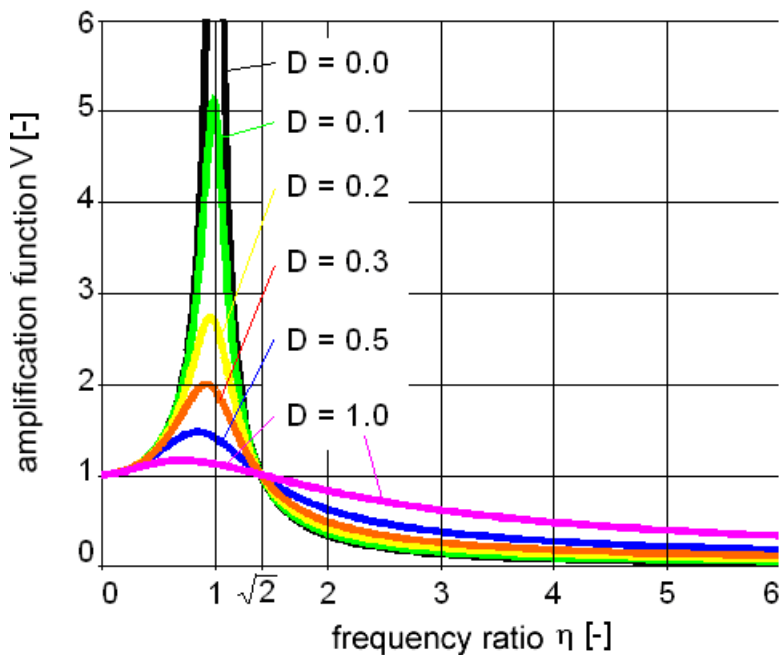

fig. 2.2 The transmissibility as a function of frequency ratio and damping

With the transmissibility in accordance with **fig. 2.2** the relation of the swinging amplitudes to the exciter amplitudes is shown. This transmissibility of the stationary state applies to harmonic force and path excitation equally.

Independently of the damping or the damping measure of D all curves run through the points $(0, 1)$ and $(\sqrt{2}, 1)$. In the point $(0, 1)$ the exciter speed is equal to zero. The amplitude is equal to the exciter amplitude (static value). Up to the point $(\sqrt{2}, 1)$

the amplitude is larger than the exciter amplitude, i.e. an increased height occurs. Only if the frequency ratio exceeds $\sqrt{2}$, the amplitudes become smaller than the exciter amplitudes. The desired isolating effect occurs. Therefore for the vibration isolation the deep tuning with a frequency ratio higher than $\sqrt{2}$ is more targeted.

From **fig. 2.2** it becomes also evident that too strong damping reduces the isolating effect: For frequency ratios higher than $\sqrt{2}$ oscillation amplitude increases with increasing damping ratio. Therefore the vibration isolation should be done without damping. However this is often impossible or only to a limited extent. Because when starting the machines in the case of deep tuning the resonance part ($h = 1$) must be passed through. In the resonance the damping limits the oscillation amplitudes: The larger the damping, the smaller the amplitudes.

Likewise from **fig. 2.2** it follows that with weak damping we can count damping free outside of the resonance: The curves for $D = 0,0$ and $D = 0,1$ are practically identical in these areas.

Finally **fig. 2.2** shows also that practical frequency ratios should be situated between 2 and 4. Larger tuning ratios do not substantially improve the isolating effect and are often connected with an untenable high expenditure.

A measure for the decrease of the oscillations and thus for the quality of the vibration isolation is the degree of isolation i . It is defined for areas of the vibration isolation thus for areas, within the transmissibility is smaller (or at the most equal) 1. It indicates, by how much per cent the oscillation amplitudes fall below the amount of the exciter amplitudes. For the oscillator with one degree of freedom it is calculated:

$$i = \left(1 - \frac{\sqrt{1 + 4D^2\eta^2}}{\sqrt{(1 - \eta^2)^2 + 4D^2\eta^2}} \right) \cdot 100 \% . \quad (2.18)$$

Under neglect of the damping formula (2.18) turns in to formula (2.19):

$$i = \frac{\eta^2 - 2}{\eta^2 - 1} \cdot 100 \% , \quad \text{for } D \text{ equals zero and } \eta^2 \geq 2 . \quad (2.19)$$

2.2 Minimum model of the two-mass oscillator

As minimum model for the double vibration isolation the two-mass oscillator can be considered in accordance with **fig. 2.3**. As degrees of freedom only two displacements in one direction are considered.

The objects with the index 1 indicate the arrangement "rigid machine is flexibly installed" in accordance with **fig. 2.1**. The objects with the index 2 represent the intermediate foundation and its flexible bearing. One can also say, the model in accor-

dance with section 2.1 was extended by a mass and a spring damper. What effect does this have on the dynamic characteristics of the system?

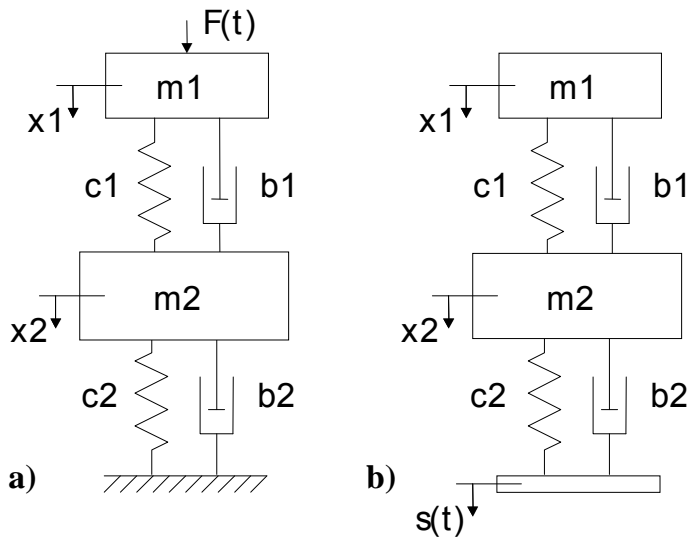

fig. 2.3 Minimum models for the double vibration isolation, two-mass oscillator
 a) Force excitation for the vibration isolation of machines
 b) Ground excitation for the vibration isolation of devices

2.2.1 Natural frequencies of the two-mass oscillator

By the additional degree of freedom the model has two natural frequencies. Where are these frequencies situated, compared with the single vibration isolation?

The formula to the calculation of the natural frequencies of the bound two-mass oscillator in accordance with **fig. 2.3** reads

$$\omega_{1,2}^2 = \frac{1}{2} \cdot \frac{c_1 \cdot (m_1 + m_2) + c_2 \cdot m_1}{m_1 \cdot m_2} \mp \sqrt{\left[\frac{1}{2} \cdot \frac{c_1 \cdot (m_1 + m_2) + c_2 \cdot m_1}{m_1 \cdot m_2} \right]^2 - \frac{c_1 \cdot c_2}{m_1 \cdot m_2}}. \quad (2.20)$$

One sets

$$c_{rel} = \frac{c_2}{c_1}, \quad m_{rel} = \frac{m_2}{m_1} \quad \text{and} \quad \omega_{1fg}^2 = \frac{c_1}{m_1}, \quad (2.21)$$

one receives

$$\frac{\omega_{1,2}}{\omega_{1fg}} = \frac{f_{eig}}{f_{1fg}} = \sqrt{\frac{1}{2} \cdot \left(1 + \frac{1}{m_{rel}} + \frac{c_{rel}}{m_{rel}} \right)} \mp \sqrt{\left[\frac{1}{2} \cdot \left(1 + \frac{1}{m_{rel}} + \frac{c_{rel}}{m_{rel}} \right) \right]^2 - \frac{c_{rel}}{m_{rel}}}. \quad (2.22)$$

The connection (2.22) is in **fig. 2.4** graphically represented. It is to be found also in [5].

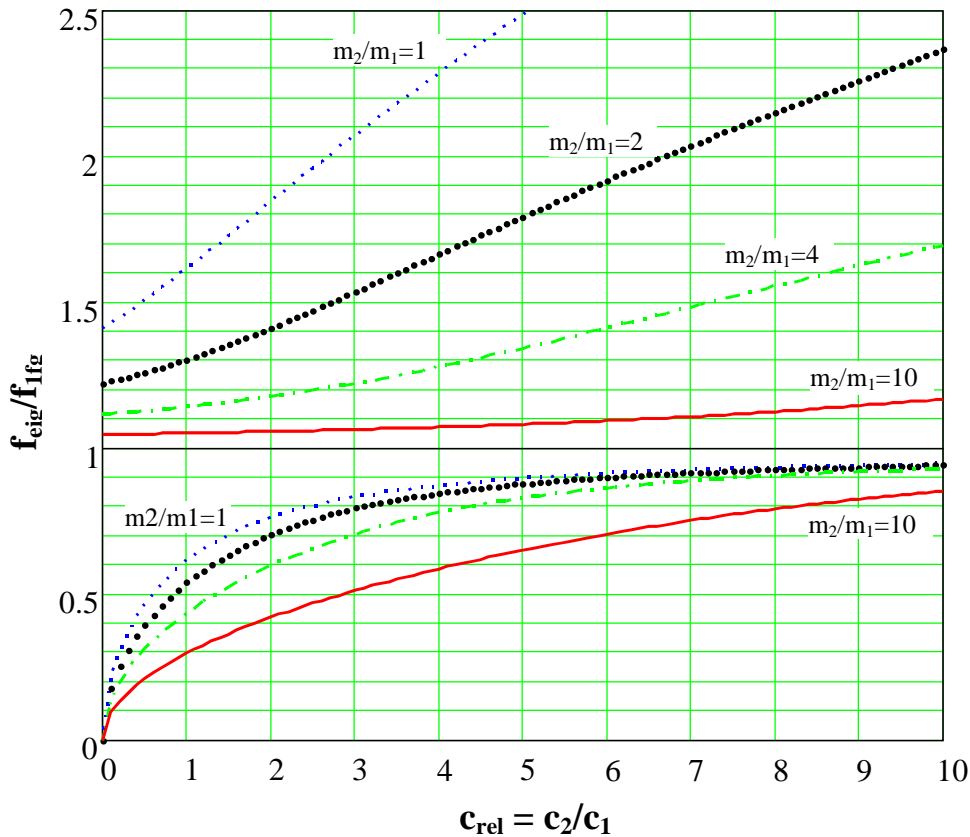

fig. 2.4 Natural frequencies of the bound two-mass oscillator, related to frequency and parameter of the one-mass oscillator

The straight line $f_{\text{eig}}/f_{1\text{fg}}=1$ in **fig. 2.4** shows the natural frequency of the one-mass oscillator (simple vibration isolation). It is interesting that the two-mass oscillator (double vibration isolation) has both a natural frequency under and above this frequency. The original frequency is split into two frequencies - into one under it and one above. This phenomenon is represented in detail in [7].

If one accepts the fact that the double vibration isolation is tried, because the possibilities of the simple are exhausted, one determines first that the double vibration isolation brings higher natural frequencies to the system. This worsens the tuning ratio of a deep tuning. In order to have only a small decrease of the distance between lowest exciter frequency (and highest natural frequency and thus the tuning ratio), the curve for the higher natural frequency should be as close as possible at the straight line ($f_{\text{eig}}/f_{1\text{fg}}=1$). That is for large m_2/m_1 and small c_2/c_1 the case. Thus the foundation mass must be as large as possible (for instance the tenfold machine mass). The stiffness of the spring elements under the foundation should not be substantially larger than the stiffness of the spring elements under the machine.

2.3 Transmissibility and degree of isolation of the two-mass oscillator

The differential equations for the two-mass oscillator in accordance with **fig. 2.3a** read (under neglect of the dampings b_1 and b_2):

$$\begin{aligned} m_1 \cdot \ddot{x}_1 + c_1 \cdot (x_1 - x_2) &= F \\ m_2 \cdot \ddot{x}_2 + c_2 \cdot x_2 - c_1 \cdot (x_1 - x_2) &= 0 \end{aligned} \quad (2.23)$$

If one uses in **(2.23)** for the force the approach **(2.3)** and for the displacements x_1 and x_2 as well as their derivations the approaches in accordance with **(2.4)** to **(2.6)**, we have after some transformations for x_2 :

$$\tilde{x}_2 = \frac{1}{1 - \frac{m_1}{c_1} \cdot \Omega^2} \cdot \frac{\tilde{F}}{c_1 + c_2 - \frac{c_1}{1 - \frac{m_1}{c_1} \cdot \Omega^2} - m_2 \cdot \Omega^2}. \quad (2.24)$$

The force on the ground results for the undamped two-mass oscillator to

$$\tilde{F}_B = c_2 \cdot \tilde{x}_2. \quad (2.25)$$

With the abbreviations **(2.21)** and

$$\eta = \frac{\Omega}{\omega_{1fg}} \quad (2.26)$$

one receives for the transfer function **(2.27)**

$$\frac{\tilde{F}_B}{\tilde{F}} = \frac{c_{rel}}{(1 - \eta^2) \cdot (1 + c_{rel} - m_{rel} \cdot \eta^2) - 1} \quad (2.27)$$

The transmissibility is finally the absolute value of the transfer function:

$$V = \left| \frac{c_{rel}}{(1 - \eta^2) \cdot (1 + c_{rel} - m_{rel} \cdot \eta^2) - 1} \right|. \quad (2.28)$$

In **fig. 2.5** the transmissibility **(2.28)** for $m = 10$ and $c = 5$ is represented over the tuning ratio η . For comparison the transmissibility of the one-mass oscillator for $D = 0$ is likewise shown.

This representation acknowledges the predicates of the section **2.1.1**. Using the maxima one detects that two have become from the original frequency of the one-mass oscillator. The higher frequency of the two-mass oscillator is situated above that of the one-mass oscillator.

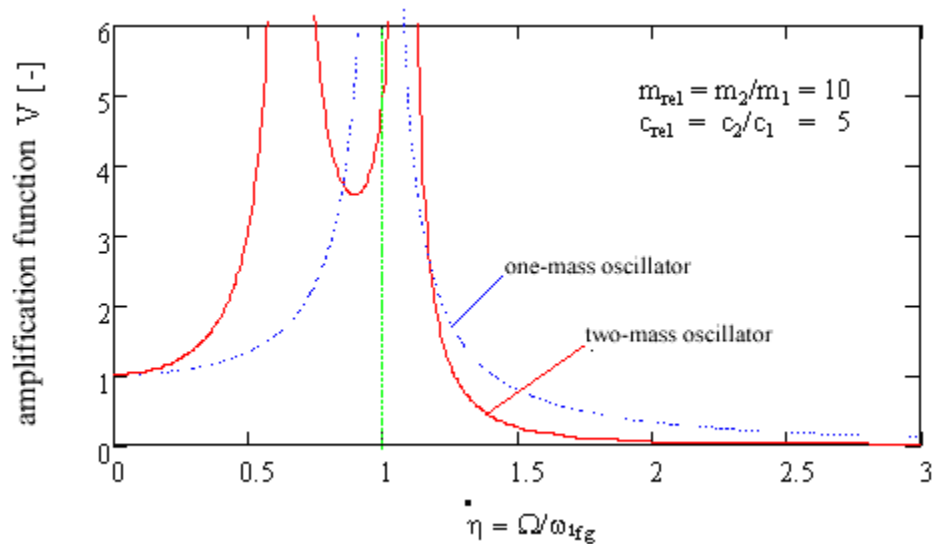

fig. 2.5 Transmissibility of the two-mass oscillator in comparison to the one - mass oscillator for deep tuning

fig. 2.5 shows that the transmissibility of the two-mass oscillator drops more strongly than those of the one-mass oscillator after crossing the resonances (particularly the second). This fact can be explained with double vibration isolation and deep tuning. One can achieve degree of isolation with same η or achieve a desired degree of isolation with lower distance to the resonance part **fig. 2.6**.

For example if a degree of isolation of 80 % is required, with the one-mass oscillator a tuning ratio η is required of 2.45. With the two-mass oscillator however a η of 1.3 for degree of isolation (**fig. 2.6**).

Here we refer to the fact that the term of the tuning ratio is not unique in the case of the two-mass oscillator. That because the two-mass oscillator has two resonance parts and we refer to only one. For better comparison with the one-mass oscillator one refers η also gladly to $\omega_{1fg} = \sqrt{c_1/m_1}$. This quantity characterizes the natural frequency of the one-mass oscillator, however, does not represent a natural frequency of the two-mass oscillator. Therefore in the following the degree of isolation is to be used, which is always unique and indicates the desired effect of the vibration isolation - which expresses the reduction of the vibration amplitude.

Additionally **fig. 2.5** shows that the improvement of the isolating effect by double vibration isolation and deep tuning is successful only within a quite narrow parameter area. If one accepts the fact that the simple vibration isolation was tried before, the thereby achieved η must be greater 1. That is, the natural frequency of the simply installed machine must be under the smallest exciter frequency. Lowering of the natural frequency of the system by the double vibration isolation is not possible. Only the degree of isolation can be improved.

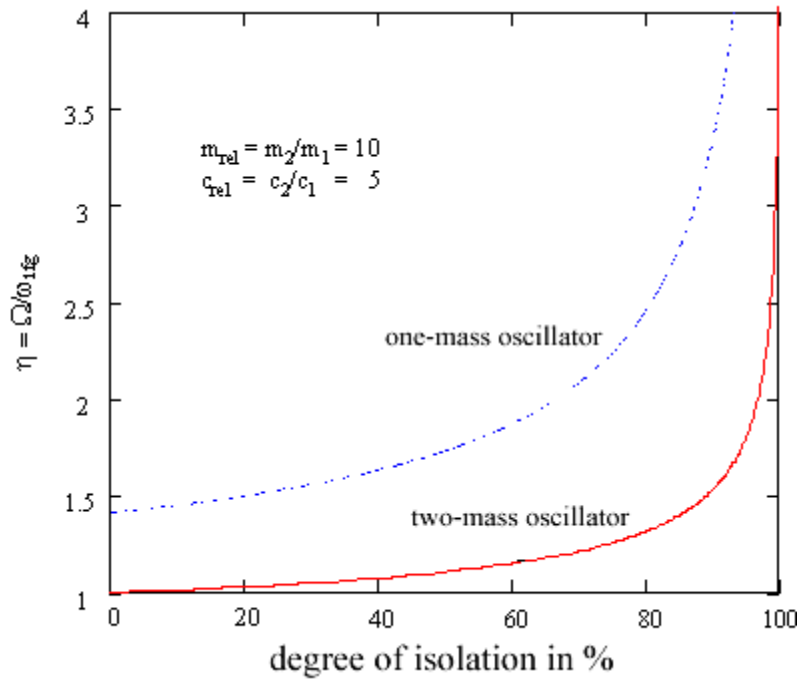

fig. 2.6 η as function of the degree of isolation for the one and two-mass oscillator

Now the mixed tuning still would be interesting. Here we want to shift both natural frequencies as far as possible beyond the exciter frequency i.e., the first natural frequency should be as low as possible and the second as high as possible. A small first natural frequency leads to a small as possible c_{rel} (**fig. 2.4**). $c_{rel} < 1$ is practically not realizable, since for the simple vibration isolation already the softest isolators (c_1) were selected, which were determined with the given loads. The isolator's c_2 must bear these loads and the load by the foundation. Thus they cannot be softer than c_1 (load capacity and stiffness of the isolators are generally indirectly proportional, i.e. moving in opposite directions). The relation of the masses should be small for the mixed tuning (a large m_{rel} was benefit for the deep tuning).

fig. 2.7 and formula (2.28) show that the transmissibility of the two-mass oscillator for $c_{rel} = 1$ with $\eta = 1$ has the value 1, i.e. the degree of isolation is 0. With $\eta = 1$ and mixed tuning an isolating effect can be achieved only for c_{rel} smaller 1, what is practically not possible for above mentioned reasons. Apart from the fact that often also resonances with the second, higher natural frequency are problematic, it drops the transmissibility of the two-mass oscillator after the first resonance part also still less strongly than after second. Therefore we can with the deep tuning.

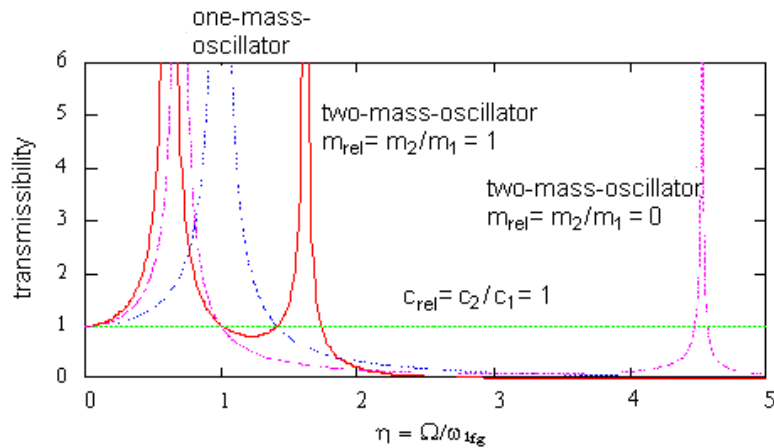

fig. 2.7 Transmissibility of the two-mass oscillator in comparison to the one-mass oscillator for mixed tuning

Still the mounting of dynamic vibration absorbers remains. Here c_2 and m_2 are stiffness and mass of the machine to be installed, c_1 and m_1 are the dynamic vibration absorber system. The practical meaning of dynamic vibration absorbers is rather low after [7], since large dynamic vibration absorber masses are required. Dynamic vibration absorbers are tuned with the exciter frequency and driven in resonance. Here we have large oscillation amplitudes of the mass (m_1) and large loads of the springs (c_1).

Thus the importance of the double vibration isolation is not as great as generally assumed. It is, nevertheless, practical to integrate this option into the program because the calculation possibilities are extended. The influence of grounds, establishments or flexible intermediate layers can be considered too.

2.4 The block foundation - The oscillator with 6 degrees of freedom

Each rigid machine installed flexibly in the space (without or with rigidly joined foundation) has 6 degrees of freedom, if one regards the installation elements as massless. For a system with 6 degrees of freedom 6 natural frequencies result. If one requires now a deep tuning, the highest natural frequency must be smaller than the lowest exciter frequency. A modeling of the setting up of machinery with only one degree of freedom is thus insufficient, since this model supplies only one natural frequency and thus 5 further remain unconsidered. It thus cannot be checked whether all of the 6 available natural frequencies are sufficiently far distant from the exciter frequencies, than it is required for the mixed tuning. Thus resonance appearances cannot be excluded.

Therefore in ISOMAG the block foundation - a rigid unit, consisting of machine and/or foundation, is considered. It is flexibly mounted and has 6 degrees of freedom. The oscillator with one degree of freedom is contained in this model as a special case.

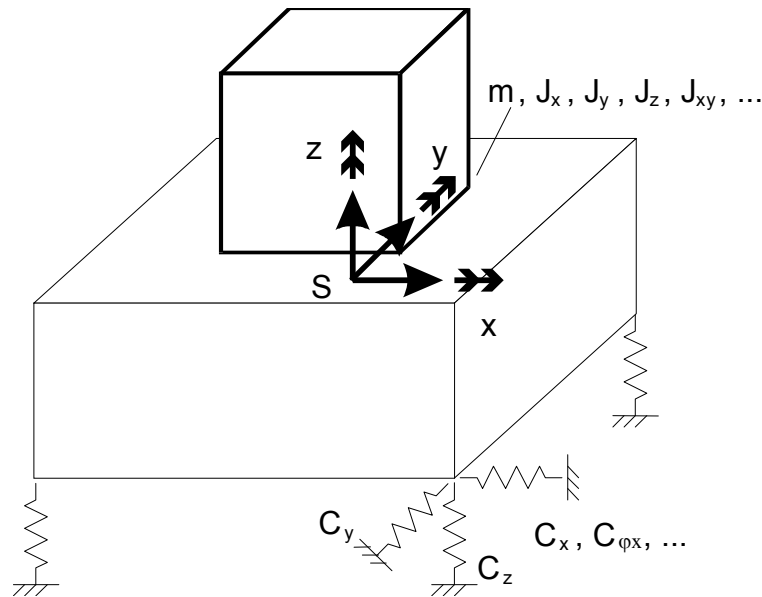

fig. 2.8 Model of the flexibly mounted block foundation, with rigid coupling machine - foundation and 6 degrees of freedom

fig. 2.8 shows the model block foundation. The coordinate system is situated in the center of mass S . The coordinates x , y , and z illustrate the three translatory degrees of freedom, while the coordinates φ_x , φ_y , and φ_z are the three rotary degrees of freedom. Concerning these 6 coordinates the inertia properties of the rigid body are $(m, J_x, J_y, J_z, J_{xy}, \dots)$. The spring damper elements can likewise have stiffness or damping in 6 directions $(c_x, c_y, c_z, c_{\varphi x}, \dots)$. Since they do not attack generally in the center of gravity and its position can be turned relative to the center of gravity coordinate system, their effect is obtained by transformation to the center of gravity system. Attacking forces and torques are likewise transformed on this coordinate system.

If one writes the motion equations for the block foundation, one receives a system of 6 formulas. In matrix notation it reads:

$$\mathbf{M}\ddot{\mathbf{x}} + \mathbf{B}\dot{\mathbf{x}} + \mathbf{C}\mathbf{x} = \mathbf{F} \quad (2.29)$$

The solution of the differential equation system **(2.29)** supplies first 6 natural frequencies and 6 eigenvectors. If results additionally are looked up in time -or frequency range, it is practical to decouple the set of equations. In addition one transforms **(2.29)** using the matrix of the eigenvectors and under certain demands to the damping matrix **[11]** to so called principal coordinates. The matrices \mathbf{M} and \mathbf{C} become thereby diagonal. The set of equations disintegrates into 6 single formulas, which correspond to the formulas of the oscillator with one degree of freedom.

The results calculated in principal coordinates can be transformed back then on each coordinate system, so that one receives e.g. the loads in the isolators or motion quantities of any points.

Details of the algorithms used in the program **ISOMAG** can be found under **3.1**.

2.5 Double vibration isolation – The oscillator with 12 degrees of freedom

The isolating effect is frequently tried to be improved with the double vibration isolation. For the modeling of the double vibration isolation two rigid bodies are required – one for the machine (including rigidly coupled components) and one for the foundation connected flexibly with the machine. Since each body has 6 degrees of freedom the system has 12 degrees of freedom and thus 12 natural frequencies. For a successful tuning all frequencies must be considered. Minimum models in accordance with section 2.2 or 2.3 are generally insufficient, however contained as a special case.

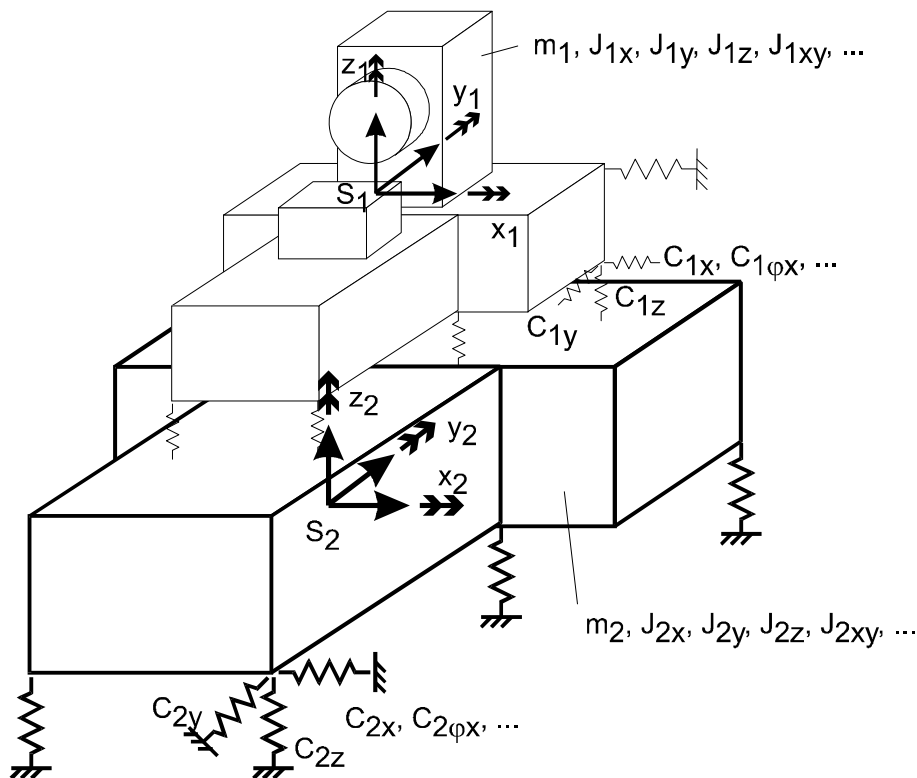

fig. 2.9 Flexibly mounted machine on flexibly mounted foundation, Model with 2 rigid bodies and 12 degrees of freedom

fig. 2.9 shows the model. We have the rigid bodies machine (index 1), and foundation (index 2). The coordinate systems are situated in the respective center of mass of the rigid bodies (S_1 and S_2). The coordinates x , y , and z illustrate the three translatory degrees of freedom, while the coordinates ϕ_x , ϕ_y , and ϕ_z are the three rotary degrees of freedom. Concerning the 6 coordinates of the rigid bodies their inertia properties are calculated ($m_1, J_{1x}, J_{1y}, \dots, J_{1z}, m_2, J_{2x}, J_{2y}, \dots$). The spring damper items can likewise have stiffness or damping in 6 directions ($c_x, c_y, c_z, c_{\phi x}, \dots$). They can be arranged between machine and foundation (index 1), foundation and rigid environment (index 2) or machine and rigid environment. Since they do not attack generally in the centers of gravity and their position can be turned concerning the centers of gravity coordinate system, their effect is converted by transformation to the center of gravity systems (tying up at body 1 on center of gravity system 1, tying up at body 2 on cen-

ter of gravity system 2). Attacking forces and torques are likewise transformed on these coordinate systems.

The further calculation can take place similarly (2.29). Exception: Now 12 formulas are to be considered, and also 12 natural frequencies and vibration modes occur.

2.6 Consideration of the dynamic characteristics of the installation place – the oscillator with 13 degrees of freedom

Often the environment or the installation place cannot be assumed as rigid. This is the case for example, if locations take place on building ceilings or ground is to be considered. The natural frequencies, forces and movement patterns of the installed machine deviate then from those with rigid environment. Since in these cases the dynamic characteristics of the environment are interesting only in vertical direction, the introduction of a further (13th) degree of freedom is sufficient: the translation of the environment in z-direction (fig. 2.15). The continuously distributed stiffness and inertia parameter of the environment can be converted in its effect on these coordinates (discrete values), as shown in the next section.

2.6.1 Bases of the consideration of the installation place

A ductile installation place, which represents a continuum (distributed stiffness and inertia parameters), can be reduced for a certain point in a discrete substitute model. If we set the position of the machine for this point or foundation, we receive the virtual parameters for the location. The substitute model and the continuum must have the same dynamic characteristics. That means that the kinetic and the potential energy of both systems must be alike with same oscillation amplitude in the point of reduction. The one-mass model can reproduce only the first natural frequency of the continuum.

How well the substitute model reflects the first natural frequency of the continuum depends on the selected approach for the displacement. If one uses the accurate vibration mode, one keeps also the frequency accurate. However, the accurate vibration modes are often unknown or the calculation would become unnecessarily complicated, so that one selects approaches, which describe the vibration mode approximately. Parabola approaches are often used, which correspond to the static displacement, or sine or cosine approaches, which can be treated computationally well. Different approaches (trigonometric or parabola) are suitable for different bearing/boundary conditions. In this project one operates constantly with trigonometric approaches. Example calculations showed that the largest deviations are approximately 3 %. For practical applications this is sufficient, since the larger uncertainties are situated in the parameters.

First the kinetic energy of the continuum is calculated with the help of an approach for the displacement of the vibration mode of the first natural frequency. From equating this energy with the kinetic energy of the substitute model the virtual mass can be determined. In the case of well-known natural frequency of the installation place then the appropriate virtual stiffness results from the frequency equation of the one-mass oscillator. If the natural frequency is not well-known, the potential energy can be cal-

culated with the same displacement approach, which supplies the virtual rigidity after equating with the potential energy of the substitute model.

Since the vibration modes are different and thus also the approaches for beams and plate as well as different bearings, in the following virtual parameter for different arrangements are calculated.

2.6.1.1 Virtual parameters for the beam hinged on both ends

fig. 2.10 shows the beam hinged on both ends, its first vibration mode as well as the selected coordinates and designations.

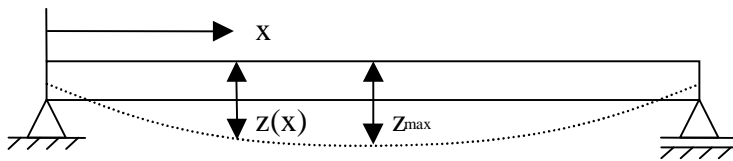

fig. 2.10 First vibration mode of a beam hinged on both ends

For a hinged beam of the length l_x for $z = f(x, t)$ the following approach is selected:

$$z(x, t) = z_{\max} \cdot \sin\left(\frac{\pi \cdot x}{l_x}\right) \cdot \sin(\omega_1 \cdot t), \quad (2.30)$$

whereby ω_1 is the first natural frequency of the beam or continuum.

The following boundary conditions are fulfilled thereby:

$$\begin{aligned} z(x = 0, t) &= 0, \\ z(x = l_x, t) &= 0 \text{ und} \\ z(x = l_x/2, t) &= z_{\max}. \end{aligned} \quad (2.31)$$

The kinetic energy of a continuum is obtained from:

$$W_{kin} = \int_0^{l_x} \rho \cdot \frac{A}{2} \cdot \dot{z}^2(x, t) \cdot dx, \quad (2.32)$$

whereby A is the cross-section area of the beam and ρ its density.

For the hinged beam follows with **(2.30)**

$$\begin{aligned}
W_{kin} &= \rho \cdot \frac{A \cdot \omega_1^2}{2} \cdot z_{max}^2 \cdot \cos^2(\omega_1 \cdot t) \cdot \int_0^{l_x} \sin^2\left(\frac{\pi \cdot x}{l_x}\right) \cdot dx \\
&= \rho \cdot \frac{A \cdot l_x}{2} \cdot \frac{z_{max}^2 \cdot \omega_1^2}{2} \cdot \cos^2(\omega_1 \cdot t) \quad , \\
&= \frac{m}{2} \cdot \frac{z_{max}^2 \cdot \omega_1^2}{2} \cdot \cos^2(\omega_1 \cdot t)
\end{aligned} \tag{2.33}$$

with the beam mass $m = \rho \cdot A \cdot l_x$.

The kinetic energy for the substitute model is calculated by:

$$\begin{aligned}
W_{kin} &= \frac{m_{ers}}{2} \cdot \dot{z}(x)^2 \\
&= \frac{m_{ers} \cdot \omega_1^2}{2} \cdot z_{max}^2 \cdot \sin^2\left(\frac{\pi \cdot x}{l_x}\right) \cdot \cos^2(\omega_1 \cdot t)
\end{aligned} \tag{2.34}$$

Equating of **(2.33)** and **(2.34)** supplies:

$$m_{ers} = \frac{m}{2 \cdot \sin^2\left(\frac{\pi \cdot x}{l_x}\right)} \tag{2.35}$$

With well-known natural frequency ω_1 of the continuum the virtual stiffness **(2.37)** from the frequency equation for the one-mass oscillator or the substitute model **(2.36)** is calculated:

$$\omega_1^2 = \frac{c}{m} = \frac{c_{ers}}{m_{ers}} \tag{2.36}$$

$$c_{ers} = \omega_1^2 \cdot m_{ers} = (2 \cdot \pi \cdot f_1)^2 \cdot m_{ers} \tag{2.37}$$

If the natural frequency is unknown, the virtual stiffness can be calculated by equating the potential energies of the continuum and the substitute model. Theoretically both methods are equivalent. Because of the uncertainties in the ceiling parameters **(2.37)** is to be preferred in practice.

The potential energy of the beam is calculated for the continuum according to **(2.38)**

$$W_{pot} = \frac{1}{2} \cdot \int_0^{l_x} E \cdot I \cdot \left(\frac{d^2 z}{dx^2}\right)^2 dx \tag{2.38}$$

E is the Young's modulus and I the geometrical moment of inertia of the cross-section area. For example for the beam with rectangular cross-sectional area the width l_y and the height l_z Inertia I can be calculated with **(2.39)**:

$$I = \frac{l_y \cdot l_z^3}{12}. \quad (2.39)$$

With the approach (2.30) results

$$W_{pot} = \frac{\pi^4 \cdot E \cdot I}{4 \cdot l_x^3} \cdot z_{max}^2 \cdot \sin^2(\omega_1 \cdot t). \quad (2.40)$$

The substitute model has the potential energy

$$W_{pot} = \frac{c_{ers}}{2} \cdot z^2. \quad (2.41)$$

Setting (2.30) in (2.41) results

$$W_{pot} = \frac{c_{ers}}{2} \cdot z_{max}^2 \cdot \sin^2\left(\frac{\pi \cdot x}{l_x}\right) \cdot \sin^2(\omega_1 \cdot t). \quad (2.42)$$

Equating the energies (2.40) and (2.42) finally supplies the virtual rigidity for the hinged beam with well-known material (young's modulus) and geometry-data (l and l_x):

$$c_{ers} = \frac{\pi^4 \cdot E \cdot I}{2 \cdot l_x^3 \cdot \sin^2\left(\frac{\pi \cdot x}{l_x}\right)}. \quad (2.43)$$

2.6.1.2 Virtual parameters for a clamped beam

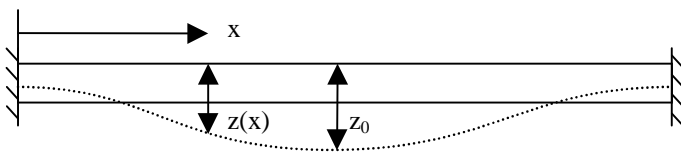

fig. 2.11 Beam clamped on both ends

For the clamped beam after fig. 2.11 the displacement approach (2.44) is selected:

$$z(x, t) = \frac{z_{max}}{2} \cdot \left(1 - \cos\left(\frac{2 \cdot \pi \cdot x}{l_x}\right)\right) \cdot \sin(\omega_1 \cdot t), \quad (2.44)$$

that fulfills the boundary conditions

$$\begin{aligned}
z(x=0, t) &= 0, \\
z(x=l_x, t) &= 0, \\
\frac{dz}{dx}(x=0, t) &= 0, \\
\frac{dz}{dx}(x=l_x, t) &= 0 \text{ und} \\
z(x=l_x/2, t) &= z_{\max}
\end{aligned} \tag{2.45}$$

The calculation of the virtual parameters is similar to section 2.6. One receives for the virtual mass

$$m_{ers} = \frac{3 \cdot m}{2 \cdot \left(1 - \cos\left(\frac{2 \cdot \pi \cdot x}{l_x}\right)\right)^2}. \tag{2.46}$$

In the case of well-known natural frequency of the installation place the virtual stiffness results according to (2.37). Otherwise it can be calculated with (2.47):

$$c_{ers} = \frac{8 \cdot \pi^4 \cdot E \cdot I}{l^3 \cdot \left(1 - \cos\left(\frac{2 \cdot \pi \cdot x}{l_x}\right)\right)^2}. \tag{2.47}$$

2.6.1.3 Virtual parameters for the rectangular plate hinged on all sides

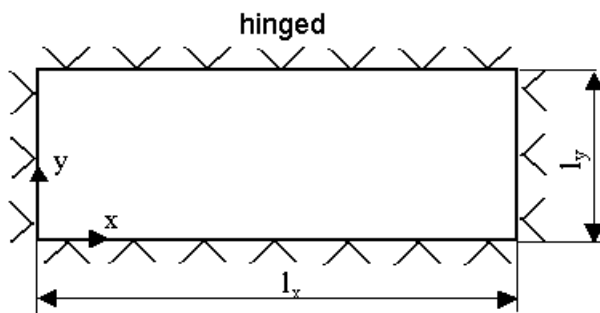

fig. 2.12 Rectangular plate hinged on all sides

For the hinged rectangular plate with the edge lengths l_x and l_y (**fig. 2.12**) the following approach for the displacement is selected:

$$z(x, y, t) = z_{\max} \cdot \sin\left(\frac{\pi \cdot x}{l_x}\right) \cdot \sin\left(\frac{\pi \cdot y}{l_y}\right) \cdot \sin(\omega_1 \cdot t). \tag{2.48}$$

It fulfills the following conditions for the displacement z :

$$\begin{aligned}
 z(x=0, y, t) &= 0, \\
 z(x=l_x, y, t) &= 0, \\
 z(x, y=0, t) &= 0, \\
 z(x, y=l_y, t) &= 0 \text{ und} \\
 z(x=l_x/2, y=l_y/2, t) &= z_{\max}.
 \end{aligned} \tag{2.49}$$

The kinetic energy of the plate is calculated for the continuum using (2.50) e.g. in [9]

$$\begin{aligned}
 W_{kin} &= \int_A \rho \cdot \frac{l_z}{2} \cdot \dot{z}^2 dA \\
 &= \rho \cdot \frac{l_z}{2} \cdot \int_{x=0}^{l_x} \int_{y=0}^{l_y} \dot{z}^2 dydx
 \end{aligned} \tag{2.50}$$

Using (2.48) in (2.50) and equating with the energy of the one-mass oscillator, we receive the virtual mass of the all-round hinged rectangular plate (2.51) (similar to section 2.6)

$$m_{ers} = \frac{m}{4 \cdot \sin^2\left(\frac{\pi \cdot x}{l_x}\right) \cdot \sin^2\left(\frac{\pi \cdot y}{l_y}\right)}. \tag{2.51}$$

In the case of well-known natural frequency of the installation place the virtual stiffness results after (2.37). Otherwise it can be determined by equating the potential energies of the continuum and the discrete one-mass oscillator. For plates potential energy is calculated by (2.52) e.g. in [9].

$$W_{pot} = \frac{1}{2} \int_0^{l_x} \int_0^{l_y} K \cdot \left[\left(\frac{d^2 z}{dx^2} \right)^2 + \left(\frac{d^2 z}{dy^2} \right)^2 + 2 \cdot \nu \cdot \left(\frac{d^2 z}{dx^2} \right) \cdot \left(\frac{d^2 z}{dy^2} \right) + 2 \cdot (1 - \nu) \cdot \left[\frac{d}{dx} \left(\frac{dz}{dy} \right) \right]^2 \right] dydx \tag{2.52}$$

Thereby ν is the Poisson's ratio. The flexural rigidity K is calculated itself by

$$K = \frac{E \cdot l_z^3}{12 \cdot (1 - \nu^2)}. \tag{2.53}$$

With the approach (2.48) the discrete virtual stiffness of the all-round articulated mounted plate results after some calculation steps:

$$c_{ers} = \frac{K \cdot \pi^4}{2 \cdot l_x \cdot l_y} \cdot \frac{\left[\frac{1}{2} \cdot \left(\frac{l_y^2}{l_x^2} + \frac{l_x^2}{l_y^2} \right) + 1 \right]}{\sin^2\left(\frac{\pi \cdot x}{l_x}\right) \cdot \sin^2\left(\frac{\pi \cdot y}{l_y}\right)}. \quad (2.54)$$

2.6.1.4 Virtual parameters for the all-side clamped rectangular plate

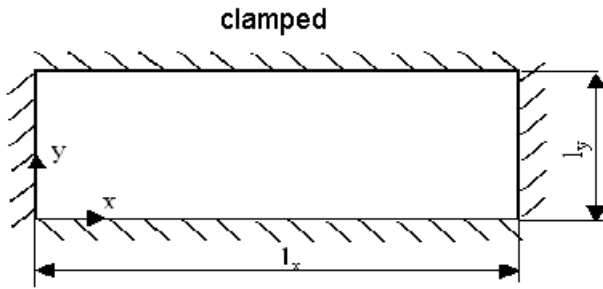

fig. 2.13 All-side clamped rectangular plate

The calculation takes place similar to section 2.6.1.3. As approach (2.55) one selects:

$$z(x, y, t) = \frac{z_{\max}}{4} \cdot \left(1 - \cos\left(\frac{2 \cdot \pi \cdot x}{l_x}\right) \right) \cdot \left(1 - \cos\left(\frac{2 \cdot \pi \cdot y}{l_y}\right) \right) \cdot \sin(\omega_1 \cdot t) \quad (2.55)$$

Additionally this approach fulfills (2.49) the condition that the tilts at the disk edges are alike to zero:

$$\begin{aligned} \frac{dz}{dy}(x=0, y, t) &= 0, \\ \frac{dz}{dy}(x=l_x, y, t) &= 0, \\ \frac{dz}{dx}(x, y=0, t) &= 0 \text{ und} \\ \frac{dz}{dx}(x, y=l_y, t) &= 0. \end{aligned} \quad (2.56)$$

The discrete virtual mass is calculated by (2.57). The discrete virtual stiffness from the plate parameters by (2.58):

$$m_{ers} = \frac{9 \cdot m}{4 \cdot \left(1 - \cos\left(\frac{2 \cdot \pi \cdot x}{l_x}\right) \right)^2 \cdot \left(1 - \cos\left(\frac{2 \cdot \pi \cdot y}{l_y}\right) \right)^2} \quad (2.57)$$

$$c_{ers} = \frac{4 \cdot K \cdot \pi^4}{l_x^3 \cdot l_y^3} \cdot \frac{3 \cdot (l_x^4 + l_y^4) + 2 \cdot l_x^2 \cdot l_y^2}{\left(1 - \cos\left(\frac{2 \cdot \pi \cdot x}{l_x}\right)\right)^2 \cdot \left(1 - \cos\left(\frac{2 \cdot \pi \cdot y}{l_y}\right)\right)^2} \quad (2.58)$$

2.6.1.5 Virtual parameters for a clamped and hinged rectangular plate

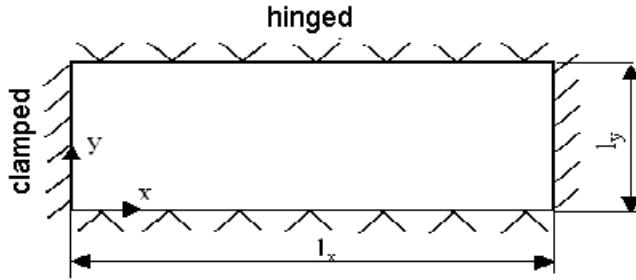

fig. 2.14 Clamped and hinged rectangular plate

The plate in **fig. 2.14** is clamped at the boundaries $x = 0$ and $x = l_x$. It is hinged at the boundaries $y = 0$ and $y = l_y$ articulated at the edges $x = 0$ and $x = l_x$. The approach for the displacement **(2.59)** is a combination off **(2.48)** and **(2.55)**

$$z(x, y, t) = \frac{z_{\max}}{2} \cdot \left(1 - \cos\left(\frac{2 \cdot \pi \cdot x}{l_x}\right)\right) \cdot \sin\left(\frac{\pi \cdot y}{l_y}\right) \cdot \sin(\omega_1 \cdot t). \quad (2.59)$$

It supplies virtual mass and virtual stiffness for the discrete model:

$$m_{ers} = \frac{3 \cdot m}{4 \cdot \left(1 - \cos\left(\frac{2 \cdot \pi \cdot x}{l_x}\right)\right)^2 \cdot \sin^2\left(\frac{\pi \cdot y}{l_y}\right)} \quad (2.60)$$

$$c_{ers} = \frac{K \cdot \pi^4}{4 \cdot l_x^3 \cdot l_y^3} \cdot \frac{16 \cdot l_y^4 + 3 \cdot l_x^4 + 8 \cdot l_x^2 \cdot l_y^2}{\left(1 - \cos\left(\frac{2 \cdot \pi \cdot x}{l_x}\right)\right)^2 \cdot \sin^2\left(\frac{\pi \cdot y}{l_y}\right)} \quad (2.61)$$

2.6.2 Structure of the complete model

With the discrete virtual parameters in accordance with section **2.6.1** results in the structure of the complete model with 13 degrees of freedom **fig. 2.15**. Models with fewer degrees of freedom are contained in this model as partial models.

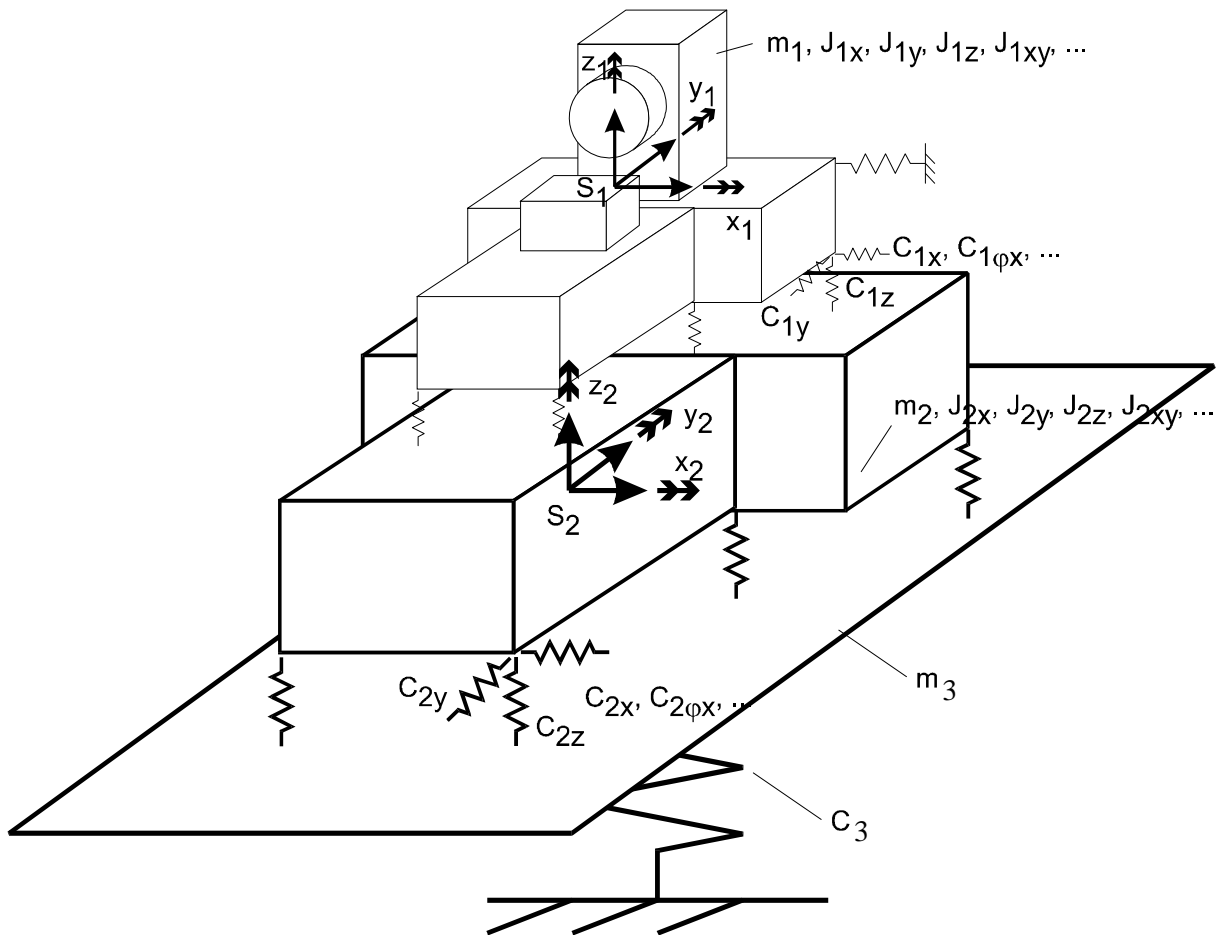

fig. 2.15 Flexibly mounted machine on flexibly mounted foundation with flexible installation place, model with 2 rigid bodies, one mass and 13 degrees of freedom

2.7 Conversion of continuously distributed stiffness to discrete parameters

In **ISOMAG** only spring elements with discrete parameters can be considered, which is completely sufficient for the modeling of discrete springs such as isolators or pipe connections.

However mats or grounds have a distributed stiffness are present. This can be converted to discrete stiffness and thus also be found in the program consideration.

2.7.1 One dimensional stiffnesses

If the stiffness effects are decoupled or if only one direction of the stiffness effect is to be regarded, the following calculation of the discrete virtual parameters can be applied.

As already described in the section **2.6.1** again the energy of the continuous model is also equated here with that of the discrete model. In the x-y plane we regard the dis-

tributed stiffness in z (**fig. 2.16**). Since it concerns a longitudinal stiffness referred to the area, it has the dimension $N/m/m^2$ resp. N/m^3 .

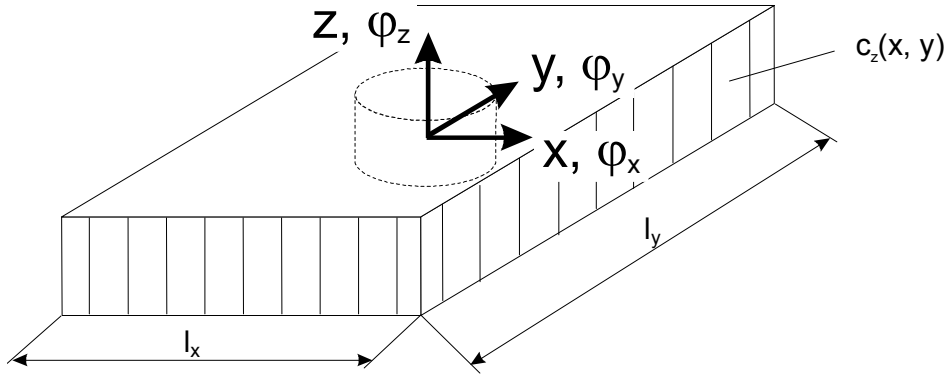

fig. 2.16 Distributed stiffness $c_z(x, y)$

As noted in [7], the potential energy of the continuum is calculated by (2.62)

$$W_{pot} = \frac{1}{2} \int_A c_z(x, y) \cdot z(x, y)^2 dA. \quad (2.62)$$

For the energy of the discrete model one can write:

$$W_{pot} = \frac{1}{2} \mathbf{x}^T \mathbf{C} \mathbf{x}. \quad (2.63)$$

Equating (2.62) and (2.63) supplies

$$\int_A c_z(x, y) \cdot z(x, y)^2 dA = \mathbf{x}^T \mathbf{C}_{ers} \mathbf{x}. \quad (2.64)$$

One notes the displacement of the continuum $z(x, y)$ dependent on the discrete displacements \mathbf{x}

$$z(x, y) = \mathbf{H}^T \mathbf{x} \quad \text{and} \quad (2.65)$$

uses (2.65) in (2.64). After some transformations one receives the matrix of the looked up virtual stiffnesses

$$\mathbf{C}_{ers} = \int_A c_z(x, y) \cdot \mathbf{H}(x, y) \cdot \mathbf{H}(x, y)^T dA. \quad (2.66)$$

For $z(x, y)$ you can write also (2.67) or (2.68); under the prerequisite that only small distortions occur, so that $\sin(\varphi) \sim \varphi$ applies:

$$z(x, y) = z + x \cdot \varphi_y - y \cdot \varphi_x \quad (2.67)$$

$$z(x, y) = [1 \quad -y \quad x] \cdot \begin{bmatrix} z \\ \varphi_x \\ \varphi_y \end{bmatrix}. \quad (2.68)$$

A comparison of (2.65) and (2.68) supplies

$$\mathbf{H}^T = [1 \quad -y \quad x] \quad (2.69)$$

$$\mathbf{H} \cdot \mathbf{H}^T = \begin{bmatrix} 1 & -y & x \\ -y & y^2 & -x \cdot y \\ x & -x \cdot y & x^2 \end{bmatrix}. \quad (2.70)$$

For constant c_z one receives with (2.66)

$$\mathbf{C}_{ers} = c_z \int \int_{l_x l_y} \begin{bmatrix} 1 & -y & x \\ -y & y^2 & -x \cdot y \\ x & -x \cdot y & x^2 \end{bmatrix} dy dx \text{ or} \quad (2.71)$$

$$\mathbf{C}_{ers} = c_z \cdot \begin{bmatrix} A & -A \cdot y_s & A \cdot x_s \\ -A \cdot y_s & I_{xx} & I_{xy} \\ A \cdot x_s & I_{xy} & I_{yy} \end{bmatrix}. \quad (2.72)$$

Here A is the area, and I_{xx} as well as I_{yy} are the geometrical moments of inertia around the x or y axis.

If one puts the discrete coordinate system into the centroid and if one additionally chooses principal coordinates, then (2.72) is transformed into

$$\mathbf{C}_{ers} = c_z \cdot \begin{bmatrix} A & 0 & 0 \\ 0 & I_{xx} & 0 \\ 0 & 0 & I_{yy} \end{bmatrix}. \quad (2.73)$$

For the rectangular area with constantly distributed stiffness thus the following discrete virtual stiffnesses for principal coordinates (coordinate directions e.g. parallel to the edges of the area) and a spring element in the centroid (area center) result:

$$\begin{bmatrix} c_{ers_z} \\ c_{ers_qx} \\ c_{ers_qy} \end{bmatrix} = c_z \begin{bmatrix} l_x \cdot l_y \\ \frac{l_x \cdot l_y^3}{12} \\ \frac{l_y \cdot l_x^3}{12} \end{bmatrix}. \quad (2.74)$$

(2.74) applies to other directions of distributed stiffness accordingly.

2.7.2 Grounds

Grounds are an example of joined distributed stiffness, i.e. the stiffness effects in different directions depend on each other.

The method after [27] is based on **the bedding number after Winkler** for the stiffness and on **the concept after Savinov** for the damping [28].

With this model for the stiffness it is assumed that independently of the form of the foundation block flexible forces only occur at the sole foundation, not at the sides. It is also to presuppose that the flexible resulting strains in one point of the bottom surface, occurring due to the foundation movement, depend on the displacement of the point are directly proportional to them.

The ground is described by the bedding number $C = C_z$ (base pressing by a vertical displacement of one unit of length) as well as a damping coefficient Φ . These values are determined from experimental data or by use of regulations from soil type, density or consistency index.

(2.75) applies to shear strain caused by horizontal translation shifts (coordinates and designations similar to **fig. 2.16**).

$$C_x = C_y = 0.7 \cdot C, \quad (2.75)$$

For vertical displacements due to a rotation of to the foundation sole around a horizontal axis of the bottom surface it holds

$$C_\varphi = 2 \cdot C. \quad (2.76)$$

For shear strain due to a rotation of the sole around the vertical axis we use

$$C_\psi = 1.05 \cdot C. \quad (2.77)$$

The damping of the ground is generally quite large. The dissipation factor d is determined with harmonic excitation by a damping factor of

$$d = \Phi \cdot \omega_{err} , \quad (2.78)$$

during impact excitation by

$$d = \Phi \cdot \omega_{eig} \quad (2.79)$$

ω_{err} is the angular frequency of excitation. ω_{eig} the excited natural frequency.

Strictly taken this approach is thereby admissible only for systems excited with only one exciter frequency or for systems with one degree of freedom. For C values within the area $C = 2 \cdot 10^4 \text{ kN/m}^3 \dots 14 \cdot 10^4 \text{ kN/m}^3$ are to be taken, Φ are situated in the area $\Phi = (0.002 \text{ s}) \dots 0.008 \text{ s}$ (after [27]).

If one calculates on this basis a stiffness matrix for a rectangular block foundation of the edge lengths l_x (x-direction) and l_y (y-direction, **fig. 2.16**) and derives from it a single spring under the prerequisite of harmonic excitation with the frequency f , then this spring receives the stiffness

$$c_x = c_y = 0.7 \cdot C \cdot A \quad \text{and} \quad (2.80)$$

$$c_z = C \cdot A \quad , \text{ also} \quad (2.81)$$

$$A = l_x \cdot l_y \quad (\text{area of the baseplate}). \quad (2.82)$$

The torsion spring stiffnesses are calculate by

$$c_{\varphi x} = 2 \cdot C \cdot I_{xx} , \quad (2.83)$$

$$c_{\varphi y} = 2 \cdot C \cdot I_{yy} \quad \text{and} \quad (2.84)$$

$$c_{\varphi z} = 1.05 \cdot C \cdot I_p , \quad (2.85)$$

where I_{xx} , I_{yy} and I_{pp} are the geometrical moments of inertia of the base plate around the x-, y- and z-axis (similar (2.72) to (2.74) and $I_p = I_{xx} + I_{yy}$).

It is presupposed that the center of gravity of the spring corresponds with the centroid of the bottom surface.

The Lehr damping factor of D same for all directions of rotation and translation is calculated by

$$D = \frac{d}{2} = \Phi \cdot \pi \cdot f , \quad (2.86)$$

where for f either the dominating exciter frequency with harmonic excitation or the smallest natural frequency with impact excitation or several exciter frequencies can

be set. In the latter case the smallest possible damping is set, so that one is on the safe side with the calculation. In the case of doubt variant calculations with different damping coefficients can help to measure the size of the error.

The example "Ground" (section **7.4.4**), supplied with **ISOMAG**, was inferred from **[27]**. The example contains a ground spring with $C = 1,2 \cdot 10^8 \text{ N/m}^3$, $\Phi = 0,007 \text{ s}$ and $f = 16.36 \text{ Hz}$.

3 Bases of the program ISOMAG

3.1 Algorithms

3.1.1 Coordinate systems

3.1.1.1 Global coordinate system (GCS)

In the global coordinate system z is selected for the vertical direction, in which the gravity force works. The axes form a right hand system and are oriented as follows: x to the right, y to the rear, z upward (cf. **fig. 3.1**). Thus the coordinate system corresponds to usual orientation in the space. It is used also by several isolator manufacturers (e.g. [19]).

In the global coordinate system the movement of machine (index 1, coordinates 1 to 6) and foundation (index 2, coordinates 7 to 12) as well as the ground (index 3, coordinate 13) is defined (**3.3**)

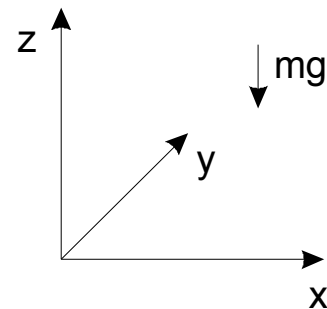

fig. 3.1 Global coordinate system

3.1.1.2 Coordinate system of machine (MCS) and foundation coordinate system (FCS)

The coordinate system of machine describes the position of the partial bodies belonging to the machine as well as the spring elements and the excitations connected to the machine. In the foundation coordinate system the position of the partial bodies and excitations belonging to the foundation as well as the spring elements connected with foundation and environment are described. Both coordinate systems can be translated in relation to the global coordinate system (rotation is impossible). As long as it is not explicitly modified by the user GCS, MCS and FCS have the same position. Thus the user can operate in the modeling simultaneously with a coordinate system, which enables the assembly of the structure without "habituation problems".

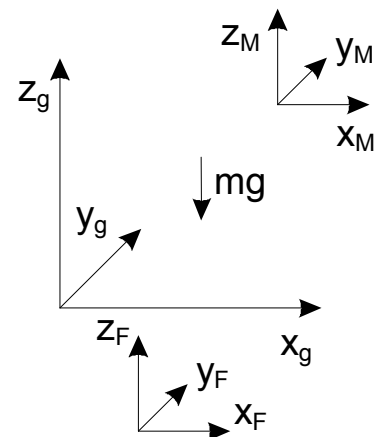

fig. 3.2 Coordinate systems for machine and foundation

If all objects belonging to the machine or to the foundation (described in MCS or FCS) are to take a new position, this is realizable over a suitable translation of the coordinate systems.

3.1.1.3 Center of gravity coordinate system (CCS)

Two centers of gravity coordinate systems are defined. The machine carries the index 1, the foundation has the index 2. The centers of gravity coordinate system are derived from the machine or foundation coordinate system by shifting into the center of the mass of the respective body. Thus the axes of both systems are parallel (cf. **fig. 3.3**). The CCS position is determined by the program and can be plotted if necessary.

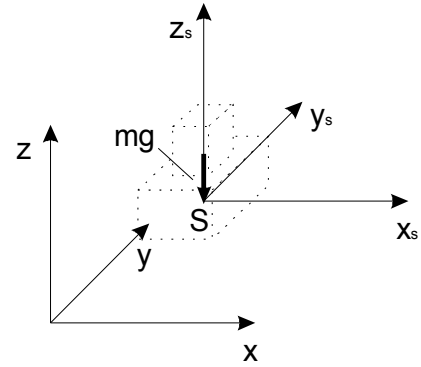

fig. 3.3 Center of gravity - coordinate system

3.1.1.4 Coordinate system of inertia principal axis (PICS)

Coordinate systems of inertia principal axis are created by a turn of the centers of gravity coordinate system into the inertia principal axes position. In this coordinate system the moments of inertia have extreme values and the products of interior are zero. Thus the mass matrix becomes a diagonal matrix. As well as the inertia principal axes systems for the machine (1) and the foundation (2) a third one for machine and foundation (3) is determined by the program. The user can display the result.

3.1.1.5 Principal coordinate system (PCS)

In principal coordinates the system is decoupled. Each formula is independent of all other formulas. All matrices (inertia, stiffness and damping) have diagonal form. This system is called a modal system. It is created by coordinate transformation and used inside the program for the calculation of the solutions in the time and frequency domain.

3.1.1.6 Element coordinate system (ECS)

Each basic body (each object) possesses a body-referred element coordinate system. It is situated in the center of gravity of the body object (cf.

fig. 3.4). In non-rotated position its axes and those of the global system (and concomitantly those of the center of gravity coordinate system) are parallel.

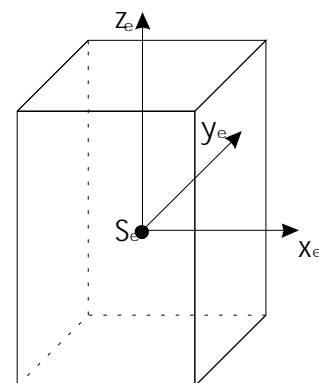

fig. 3.4 Element coordinate system

3.1.1.7 Reference coordinate system (RCS)

For a better description of the position of an object concerning the total system, objects can have a reference point. Object manipulations refer to it. RCS can be transferred by pure translation into the ECS (fig. 3.5). If no special reference point is given for an object, RCS and ECS have the same position.

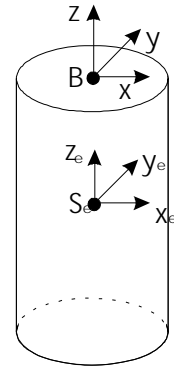

fig. 3.5 Reference coordinate system

3.1.2 Coordinate transformations

The properties of the objects can be represented and described in many coordinate systems. The individual coordinate systems for different subtasks are suitably different. If one wants to use the benefits of special coordinate systems, one must permit several coordinate systems. If one describes for example the inertia and stiffness properties of the objects suitably in element coordinates, one solves the motion equations better in principal coordinates, since in this system the formulas are decoupled. By coordinate transformation the contexts represented in a coordinate system can be converted to another.

For the transformation of the motion quantities of the element coordinate system ECS on the global coordinate system GCS one can write for example:

$$\mathbf{x}_e = \mathbf{T}_{eg} \mathbf{x}_g. \quad (3.1)$$

The vector contains the \mathbf{x}_e displacement components (the three shifts x , y and z as well as the three distortions φ_x , φ_y and φ_z) in element coordinates:

$$\mathbf{x}_e = \begin{bmatrix} x_e \\ y_e \\ z_e \\ \varphi_{x_e} \\ \varphi_{y_e} \\ \varphi_{z_e} \end{bmatrix} \quad (3.2)$$

and the vector \mathbf{x}_g the values in GCS:

$$x_g = \begin{bmatrix} x_{g1} \\ y_{g1} \\ z_{g1} \\ \varphi_{xg1} \\ \varphi_{yg1} \\ \varphi_{zg1} \\ x_{g2} \\ y_{g2} \\ z_{g2} \\ \varphi_{xg2} \\ \varphi_{yg2} \\ \varphi_{zg2} \\ z_{g3} \end{bmatrix}. \quad (3.3)$$

Since the element coordinates have the dimension 6, however in GCS 13 coordinates are defined, the transformation matrix \mathbf{T}_{eg} must have the dimension 6x13. Yet another allocation of the element coordinates to the global coordinates must take place beside the actual coordinate transformation (consideration of turn and distance). The allocation depends on which bodies the elements are connected. If they are connected with several elements, a transformation must take place for each link.

In accordance with section 3.1 the coordinate systems can be transferred by translation and/or rotations into each another. In the matrix (3.4) first these two parts are considered, whereby the rotation can be assigned to the submatrix \mathbf{P} and the translation to the submatrix \mathbf{S} :

$$\mathbf{T}_{eg\ teil} = \begin{bmatrix} \mathbf{P}_{eg} & \mathbf{P}_{eg} \mathbf{S}_{eg} \\ 0 & \mathbf{P}_{eg} \end{bmatrix} \quad (3.4)$$

The element coordinate system is rotated in such a way that its axes and those of the global coordinate system are parallel. The matrix \mathbf{P}_{eg} (dimension 3x3) contains the directional cosines. They are calculated by ISOMAG from the input angles around the individual axes (PhiX, PhiY and PhiZ) cf. section 4.5.3.2. The subsequent translation is described by the matrix \mathbf{S}_{eg} (dimension 3x3). It likewise contains the distances X, Y, and Z input in section 4.5.3.2:

$$\mathbf{S}_{eg} = \begin{bmatrix} 0 & Z & -Y \\ -Z & 0 & X \\ Y & -X & 0 \end{bmatrix}. \quad (3.5)$$

(3.5) applies for the standard case that MCS, FCS and GCS coincide. Strictly speaking the objects are described concerning MCS or FCS (fig. 4.3) so that generally another transformation is required.

\mathbf{T}_{eg} (dimension 6x13) is formed from the matrix $\mathbf{T}_{eg\ teil}$ (dimension 6x6) - depending on with which rigid bodies the elements are connected. It is built of 2 matrixes 6x6 for the transformation on the rigid bodies 1 and 2 as well as a column vector 6x1 for the transformation on the flexible environment 3:

$$\mathbf{T}_{eg}[6 \times 13] = \begin{bmatrix} [6 \times 6] & [6 \times 6] & [6 \times 1] \end{bmatrix} \quad (3.6)$$

Since the environment is flexibly assumed only in z, for this a vector is sufficient. This column vector is formed for this matrix (if necessary) from $\mathbf{T}_{eg\ teil}$ and is the third column (z-shift in global direction).

a) Element is connected with body 1 (machine) and rigid environment

$$\mathbf{T}_{eg} = \begin{bmatrix} \mathbf{T}_{eg\ teil} & \mathbf{0} & \mathbf{0} \end{bmatrix} \quad (3.7)$$

b) Element is connected with body 1 (machine) and body 2 (foundation)

$$\mathbf{T}_{eg} = \begin{bmatrix} \mathbf{T}_{eg\ teil} & -\mathbf{T}_{eg\ teil} & \mathbf{0} \end{bmatrix} \quad (3.8)$$

c) Element is connected with body 1 (machine) and flexible environment 3

$$\mathbf{T}_{eg} = \begin{bmatrix} \mathbf{T}_{eg\ teil} & \mathbf{0} & -[\mathbf{T}_{eg\ teil}]_{\bullet,3} \end{bmatrix} \quad (3.9)$$

d) Element is connected with body 2 (foundation) and flexible environment 3

$$\mathbf{T}_{eg} = \begin{bmatrix} \mathbf{0} & \mathbf{T}_{eg\ teil} & -[\mathbf{T}_{eg\ teil}]_{\bullet,3} \end{bmatrix} \quad (3.10)$$

e) Element is connected with bodies 2 (foundation) and rigid environment

$$\mathbf{T}_{eg} = \begin{bmatrix} \mathbf{0} & \mathbf{T}_{eg\ teil} & \mathbf{0} \end{bmatrix} \quad (3.11)$$

f) Element is connected with flexible and rigid environment

$$\mathbf{T}_{eg} = \begin{bmatrix} \mathbf{0} & \mathbf{0} & [\mathbf{T}_{eg\ teil}]_{\bullet,3} \end{bmatrix} \quad (3.12)$$

Examples of the case f) are the flexible environment itself, or force excitations, which affect the flexible environment.

Several transformations can be executed one after another. The product of the individual transformation matrixes is equal to the matrix, which describes the total transformation, e.g.:

$$\mathbf{x}_g = \mathbf{T}_{gs} \mathbf{x}_s. \quad (3.13)$$

Formula (3.13) used in (3.1):

$$\mathbf{x}_e = \mathbf{T}_{eg} \mathbf{T}_{gs} \mathbf{x}_s \text{ or} \quad (3.14)$$

$$\mathbf{x}_e = \mathbf{T}_{es} \mathbf{x}_s \text{ with} \quad (3.15)$$

$$\mathbf{T}_{es} = \mathbf{T}_{eg} \mathbf{T}_{gs}. \quad (3.16)$$

The transformation from element to global coordinates can be assembled also from two coordinate transformations. First the element coordinates are transformed to the machine or foundation coordinate system and afterwards to the global coordinate system.

During the transformation on centers of gravity coordinates it is to ensure that index 1 is transformed to the center of gravity of the body 1 (machine) and index 2 is transformed to the center of gravity of the body 2 (foundation).

$$\mathbf{T}_{gs} = \begin{bmatrix} \mathbf{E} & \mathbf{S}_{gs1} & \mathbf{0} & \mathbf{0} & 0 \\ \mathbf{0} & \mathbf{E} & \mathbf{0} & \mathbf{0} & 0 \\ \mathbf{0} & \mathbf{0} & \mathbf{E} & \mathbf{S}_{gs2} & 0 \\ \mathbf{0} & \mathbf{0} & \mathbf{0} & \mathbf{E} & 0 \\ 0 & 0 & 0 & 0 & 1 \end{bmatrix} \quad (3.17)$$

With the transformation matrices derived here for the displacements also different relations and variables can be converted, as the forces and torques:

$$\mathbf{F}_g = \mathbf{T}_{eg}^T \mathbf{F}_e, \text{ also} \quad (3.18)$$

$$\mathbf{F}_e = [F_{ex} \quad F_{ey} \quad F_{ez} \quad M_{ex} \quad M_{ey} \quad M_{ez}]^T \text{ and} \quad (3.19)$$

$$\mathbf{F}_g = [F_{gx1} \quad F_{gy1} \quad F_{gz1} \quad M_{gx1} \quad M_{gy1} \quad M_{gz1} \quad F_{gx2} \quad F_{gy2} \quad F_{gz2} \quad M_{gx2} \quad M_{gy2} \quad M_{gz2} \quad F_{gz3}]^T \quad (3.20)$$

or parameters like the stiffnesses:

$$\mathbf{C}_g = \mathbf{T}_{eg}^T \mathbf{C}_e \mathbf{T}_{eg}. \quad (3.21)$$

3.1.3 Calculation of the inertia properties

In order to be able to better describe the inertia properties of the system, one divides it into partial bodies. The partial bodies have a simple geometry (cuboids, cylinders, prisms or spheres) or their inertia properties are known. In ISOMAG the inertia properties for the rigid body assembled from partial bodies (machine and foundation) are then calculated as well as for machine plus foundation together (on the assumption of rigid linkage).

If „Automatic recalculation" (cf. **4.4.4**) is switched on, after each manipulation, which has an effect on the inertia matrix of the system (e.g. parameter changes, translation, rotation, adding or removing of partial bodies), inertia matrix, position of the center of gravity, principal moments of inertia and position of the principal inertia axes are calculated again. The position of the inertia principal axes system is represented graphically.

3.1.3.1 Calculation of the element mass matrices

First the inertia properties for the element are calculated. Due to the position of the element coordinate system it is sufficient to calculate with cuboid, cylinder and sphere, the element moments of inertia J_{exx} , J_{eyy} and J_{ezz} as well as the element mass m_e . The prism must additionally be determined by the deviation moment of inertia J_{exy} . The relations shown in **Table 7.1** are used, whereby the not specified deviation moments of inertia are equal to zero. For CAD import bodies or free prisms the mass matrix (which can be a dense matrix) is computed automatically or can be input manually.

During direct input of the mass or from mass and moment of inertia moments the further calculation with the input values takes place. For the given sizes thereby a calculation is omitted in accordance with **Table 7.1**.

The element mass matrix \mathbf{M}_e results thus as follows:

$$\mathbf{M}_e = \begin{bmatrix} m_e & 0 & 0 & 0 & 0 & 0 \\ 0 & m_e & 0 & 0 & 0 & 0 \\ 0 & 0 & m_e & 0 & 0 & 0 \\ 0 & 0 & 0 & J_{exx} & J_{exy} & J_{exz} \\ 0 & 0 & 0 & J_{eyx} & J_{eyy} & J_{eyz} \\ 0 & 0 & 0 & J_{ezx} & J_{ezy} & J_{ezz} \end{bmatrix} \quad (3.22)$$

3.1.3.2 The mass matrix in centers of gravity coordinates (CCS)

The summation of the element matrices to the mass matrix takes place accumulating in centers of gravity coordinates of the machine or the foundation. Since with each having added mass the position of the center of gravity changes, this is calculated first. It can be calculated from the past mass and the mass of the partial body which can be summed as well as the distance of both centers of mass. With the new center of gravity also the position of the center of gravity coordinate system is defined again. In accordance with the transformation relations presented under section **3.1.2** both the element mass matrix and the past mass matrix can be transformed and summed on the new CCS.

The mass matrices written concerning CCS have the following special appearance:

$$\mathbf{M}_s = \begin{bmatrix} m_{ges} & 0 & 0 & 0 & 0 & 0 \\ 0 & m_{ges} & 0 & 0 & 0 & 0 \\ 0 & 0 & m_{ges} & 0 & 0 & 0 \\ 0 & 0 & 0 & J_{sxx} & J_{sxy} & J_{sxz} \\ 0 & 0 & 0 & J_{syx} & J_{syy} & J_{syz} \\ 0 & 0 & 0 & J_{szx} & J_{szy} & J_{szz} \end{bmatrix} \quad (3.23)$$

3.1.3.3 Calculation of principal axes of inertia

The calculation of the position of the principal axes and the principal moments of inertia can take place, by the mass matrices \mathbf{M}_s being transformed to diagonal form. This leads to a eigenvalue problem, for which there are different algorithms in the literature (e.g. [25]) **ISOMAG** uses [26] for the numerical solution the algorithm of Martin, Parlett, Peter, Reinsch and Wilkinson.

Since the moments of inertia are not joined with the masses in \mathbf{M}_s and additionally the mass for all three translation coordinates is equal to m , it is sufficient, to transform the 3x3 partial matrixes of the moments of inertia. With

$$\mathbf{M}_{s22} = \begin{bmatrix} J_{sxx} & J_{sxy} & J_{sxz} \\ J_{syx} & J_{syy} & J_{syz} \\ J_{szx} & J_{szy} & J_{szz} \end{bmatrix} \quad (3.24)$$

the eigenvalue problem is written as follows

$$(\mathbf{M}_{s22} - \lambda_i \mathbf{E})\mathbf{V} = \mathbf{0}. \quad (3.25)$$

The orthonormalized matrix \mathbf{V} from formula (3.25) is equal to the matrix of the directional cosine \mathbf{P}_{st} , which describes the rotation of the center of gravity coordinate system in the principal axes of inertia system. The eigenvalues λ_i (3.25) are equal to the principal moments of inertia. Thus the following mass matrix \mathbf{M}_t for the inertia principal axes position results:

$$\mathbf{M}_t = \begin{bmatrix} m & & & & & \\ & m & & & & \\ & & m & & & \\ & & & \lambda_1 & & \\ & & & & \lambda_2 & \\ & & & & & \lambda_3 \end{bmatrix}. \quad (3.26)$$

Likewise with that the position of the center of gravity, the matrix of the direction cosine \mathbf{P}_{st} and the diagonals of the matrix \mathbf{M}_t the principal inertia properties are found. From the matrix of the direction cosine the somewhat more descriptive angles can be determined, which indicate, how far successively around the individual axes must be rotated, in order to transfer the CCS into the PICS (cf. section 4.8.1).

The eigenvalue problem is solved once for the machine (index 1) and the foundation (Index2) with the virtual mass of the environment m_3 and (3.26) the following total mass matrix \mathbf{M}_{tges} for the inertia principal axes position results for the system:

$$\mathbf{M}_{tges} = \begin{bmatrix} \mathbf{M}_{t1} & \mathbf{0} & 0 \\ \mathbf{0} & \mathbf{M}_{t2} & 0 \\ 0 & 0 & m_3 \end{bmatrix} \quad (3.27)$$

Additionally the inertia axes are calculated and output on machine and foundation (on the assumption of rigid coupling).

3.1.4 Calculation of the stiffness properties

If "Automatic recalculation" (cf. 4.4.4.3) is switched on, after each manipulation, which has effect on the stiffness matrix of the system (e.g. value input, tracking, adding or deletion of spring elements) stiffness matrix, spring center of gravity, principal displacement stiffness as well as the position of the principal stiffness axes are again calculated. The position of the spring principal axis system is represented graphically.

3.1.4.1 General remarks on the stiffness matrices

The element stiffness matrix is valid in the element coordinate system. The element coordinate system is situated in the flexible center of the installation elements, which generally is in the center and is not identical to the reference coordinate system (coupling point). Therefore first the position of the flexible center or the object center of gravity related to MCS or FCS (according to whether the isolators are defined concerning machine or foundation) (fig. 4.3) is to be calculated. For the standard case (MCS, FCS and GCS are identical) applies:

$$\begin{bmatrix} X \\ Y \\ Z \end{bmatrix} = \begin{bmatrix} X_b \\ Y_b \\ Z_b \end{bmatrix} + \mathbf{P}_{eg} \begin{bmatrix} 0 \\ 0 \\ -\frac{l_z}{2} \end{bmatrix}. \quad (3.28)$$

In the flexible center the force displacement relations is decoupled, and the stiffness matrix is a diagonal matrix. It has the following appearance:

$$\mathbf{C}_e = \begin{bmatrix} c_x & 0 & 0 & 0 & 0 & 0 \\ 0 & c_y & 0 & 0 & 0 & 0 \\ 0 & 0 & c_z & 0 & 0 & 0 \\ 0 & 0 & 0 & c_{\varphi x} & 0 & 0 \\ 0 & 0 & 0 & 0 & c_{\varphi y} & 0 \\ 0 & 0 & 0 & 0 & 0 & c_{\varphi z} \end{bmatrix}. \quad (3.29)$$

If no characteristic curves are given, the input values are entered into the matrix.

If there are characteristic curves, the stiffness must be selected depending on the load. Stiffness and internal load influence each other. In this case ISOMAG calculates the stiffness matrix iteratively.

Generally foundations are statically indeterminate. More spring elements are used than degrees of freedom are available. Thus the loads in the individual elements depend on stiffness conditions of the system. The iteration must include therefore the stiffness matrix of the system. That is, the element stiffness matrix \mathbf{C}_e and stiffness matrix in global coordinates \mathbf{C}_g are alternating structured and are both available at the end of the iteration.

Since the iteration supplies the looked up static displacements and loads at the same time, it is always at least once passed through, even if one operates with constant stiffness values.

Additionally with nonlinear stiffness it is to be noted that for the statics another stiffness matrix is required than for the dynamics.

The stiffness matrix of the statics is used to describe the connection between static load and static displacement. Therefore in this case C_{eff} the "effective stiffness:"

$$C_{eff} = \frac{F}{s}. \quad (3.30)$$

must be used.

For the dynamics or the oscillation behavior the real stiffness, thus the rise of the characteristic curve (force displacement characteristic curve of the spring) at the actual point of operation is important. For oscillations with low amplitudes around the static rest position it can be assumed that the position of the point of operation is constant and will be determined by static conditions. Additionally the stiffness can be assumed linear for small displacements. The stiffness C_{lin} linearized around the point of operation results to:

$$C_{lin} = \frac{dF(F_{stat})}{ds(s_{stat})}. \quad (3.31)$$

3.1.4.2 The stiffness matrix for the static calculation

First the matrices for the static calculation are build up using the effective stiffness **(3.30)** iteratively. ISOMAG uses the algorithm shown in the appendix **fig. 7.1**.

3.1.4.3 If the matrix cannot be inverted...

If the model is statically indeterminate or has only one or two degrees of freedom, the complete 13x13 stiffness matrix cannot be inverted. Therefore a technique is used, which inverts the matrix C, as far as this is possible. One divides the part-inverted matrix **K** as follows in submatrices:

$$\mathbf{K} = \begin{bmatrix} \mathbf{K}_{11} & \mathbf{K}_{12} \\ \mathbf{K}_{21} & \mathbf{K}_{22} \end{bmatrix}. \quad (3.32)$$

\mathbf{K}_{11} is the submatrix, for which a substitution has already taken place, and the main diagonal of \mathbf{K}_{22} is filled with zeros, so that no further substitution is possible. The part-inverted set of equations looks as follows:

$$\begin{bmatrix} \mathbf{x}_1 \\ \mathbf{F}_2 \end{bmatrix} = \begin{bmatrix} \mathbf{K}_{11} & \mathbf{K}_{12} \\ \mathbf{K}_{21} & \mathbf{K}_{22} \end{bmatrix} \cdot \begin{bmatrix} \mathbf{F}_1 \\ \mathbf{x}_2 \end{bmatrix}, \quad (3.33)$$

whereby the vector **x** contains the displacements and the vector **F** contains the external loads.

A solution can be found, if in the coordinate directions \mathbf{x}_2 , no displacements occur anyway. Then $\mathbf{F}_2 = \mathbf{K}_{21} \cdot \mathbf{F}_1$ must be fulfilled. In this case \mathbf{x}_1 from $\mathbf{K}_{11} \cdot \mathbf{F}_1$ and \mathbf{x}_2 is calculated directly and is **0**. Thus the searched displacements **x** are found. The model is then for example two or one dimensional.

If $\mathbf{F}_2 \neq \mathbf{K}_{21} \cdot \mathbf{F}_1$, the system is statically indeterminate and a error message appears. The calculation is aborted and the user receives the possibility of correcting the system.

3.1.4.4 Calculation of the principal translatory stiffnesses and axes

The principal translatory stiffness is calculated on the basis of the static stiffness matrix, since it will be used to align machine and foundation in the static case (cf. section **4.8.1.2**).

One gets the principal stiffness by **[10]** solving the following eigenvalue problem:

$$(\mathbf{C}_{oi} - \lambda_j \mathbf{E})\mathbf{V} = \mathbf{0}. \quad (3.34)$$

The eigenvalues λ_j are equal to the principal stiffness, the matrix of the eigenvectors **V** contains the direction cosine (possibly after orthonormalization), which indicate the rotation of the principal stiffness concerning the global coordinate system.

The matrix \mathbf{C}_{0i} is a 3x3 matrix and can be found from submatrix of the global stiffness matrix **(3.35)**.

$$\mathbf{C}_g = \begin{bmatrix} \mathbf{C}_{01} & \mathbf{C}_{11} & \mathbf{C}_{\dots} & \mathbf{C}_{\dots} & c_{\dots} \\ \mathbf{C}_{11}^T & \mathbf{C}_{21} & \mathbf{C}_{\dots} & \mathbf{C}_{\dots} & c_{\dots} \\ \mathbf{C}_{\dots}^T & \mathbf{C}_{\dots}^T & \mathbf{C}_{02} & \mathbf{C}_{12} & c_{\dots} \\ \mathbf{C}_{\dots}^T & \mathbf{C}_{\dots}^T & \mathbf{C}_{12}^T & \mathbf{C}_{22} & c_{\dots} \\ c_{\dots} & c_{\dots} & c_{\dots} & c_{\dots} & c_{33} \end{bmatrix}. \quad (3.35)$$

If you want to align the machine (and with it rigid connected components) horizontally, the stiffnesses connected to the machine are of interest. They are all defined in the submatrix **C01** (**C01** contains all translatory stiffnesses between machine and foundation, between machine and rigid environment as well as between machine and elastic environment). For the calculation of the principal stiffness for the machine

$$\mathbf{C}_{0i} = \mathbf{C}_{01} \quad (3.36)$$

will be used in **(3.34)**.

For the adjustment of the foundation the translatory stiffness defined between foundation and environment is required. One receives it from \mathbf{C}_{02} , however still the stiffness connected with the machine must be subtracted from \mathbf{C}_{02} :

$$\mathbf{C}_{0i} = \mathbf{C}_{02} - \mathbf{C}_{01} \quad (3.37)$$

\mathbf{C}_{0i} after **(3.7)** contains therefore all defined translatory stiffnesses between foundation and rigid environment as well as between foundation and elastic environment. With that the principal stiffness for the foundation is calculated after **(3.34)**.

If eigenvalues equal to zero occur with the solution of **(3.34)**, the corresponding main stiffness is equal to zero - the system cannot take up loads in these directions. Since already a static check has taken place (section **3.1.4.3**) no loads occur in these directions. The model is thus one or two dimensional.

Thus the value (λ) and direction (\mathbf{V}) of the main stiffness are known. In order to be able to represent it graphically another point is required, through which they run. One receives this point from the distance vectors \mathbf{a}_j , which result after **[10]** from the following cross product:

$$\mathbf{a}_j = \frac{\mathbf{v}_j \times (\mathbf{C}_{1i}^T \cdot \mathbf{v}_j)}{\lambda_j \mathbf{v}_j^2} \quad (3.38)$$

The vectors \mathbf{v}_j are thereby the eigenvectors, from the columns of the matrix \mathbf{V} from formula **(3.34)**. The distance vectors are required and calculated only for $\lambda_j > 0$. For the machine $\mathbf{C}_{1i}^T = \mathbf{C}_{11}^T$ is et, for the foundation $\mathbf{C}_{1i}^T = \mathbf{C}_{12}^T$.

3.1.4.5 Calculation of the center of elasticity

Centers of elasticity do only exist, if there is a point of intersection of the directions of the principal stiffnesses.

The calculation of this intersection leads to a set of equations. If it is solvable, the intersection exists. If one uses again a solution technique, which permits a partial inverting of the matrix (cf. section 3.1.4.3) one receives also an intersection for one or two dimensional models.

A center of elasticity is calculated for the machine and a further one for the foundation (similar to principal translatory stiffnesses).

3.1.4.6 The stiffness matrix for the dynamic calculation

If the stiffness is nonlinear, the stiffness matrices for the static and dynamic calculation (section 3.1.4) differ. The dynamic stiffness matrix is built up using the following algorithm:

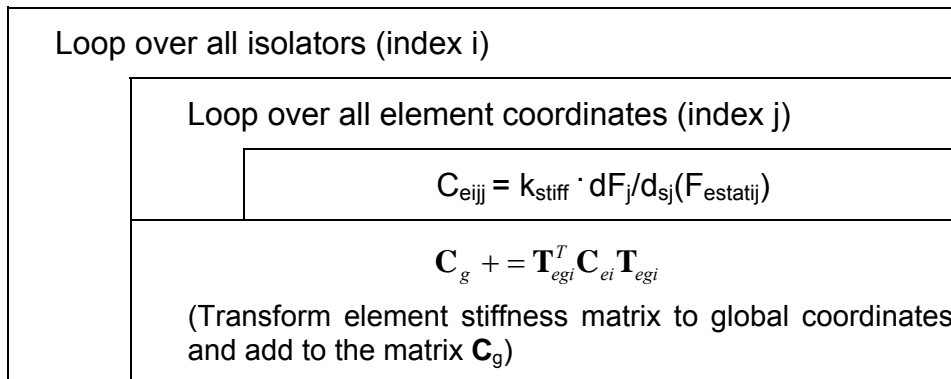

fig. 3.6 Buildup of the stiffness matrix for the dynamic calculation

The factor " k_{stiff} " considers the stiffening of flexible materials at higher velocities (idleness, creep behavior of the material). It is the relationship of the stiffness in dynamic case to stiffness in the static case.

With consideration of the stiffness of the installation place its stiffness c_3 is added to the element $C_{g[13,13]}$.

3.1.5 Static Calculation

The static loads F_{estati} and displacements x_{ei} in the isolator elements were already calculated when building up the stiffness matrix in accordance with point 3.1.4.2. The displacements determined the global coordinate system x_g can be converted with transformation relations similar to section 3.1.2 to any point in the system, so also to the centers of gravity. Also the force vector F_g calculated concerning the global coordinate system can be transformed to other points. One receives then the total of all initiated external forces, which are in the static case, the reaction forces (forces in the installation elements) - related to this point.

Additionally in all isolators (and in each coordinate direction) it is checked whether the input specified values for load and displacement are kept. A check takes place only, if at least one limiting value (maximum or minimum) is not equal to zero. If both limiting values are zero, it is assumed that no limitation exists for this load direction (cf. **fig. 7.2**).

It is possible to switch off the calculation of the static displacement. This feature is useful for systems with automatic leveling (airsprings), where the static displacements are compensated automatically.

3.1.6 Natural frequencies and vibration modes

ISOMAG calculates the natural frequencies and vibration modes of the undamped system. This leads to an eigenvalue problem. Its solution is simplified if the mass matrix is a diagonal matrix. The diagonal mass matrix \mathbf{M}_t was already structured in section 3.1.3.3. It applies in PICS.

For compatibility reasons the stiffness matrix must be likewise transformed into the inertia principal axes system. This occurs as follows:

$$\mathbf{C}_t = \mathbf{T}_{st}^T \mathbf{T}_{gs}^T \mathbf{C}_g \mathbf{T}_{gs} \mathbf{T}_{st}, \text{ with } \mathbf{T}_{st} = \begin{bmatrix} \mathbf{P}_{st1} & \mathbf{0} & \mathbf{0} & \mathbf{0} & 0 \\ \mathbf{0} & \mathbf{P}_{st1} & \mathbf{0} & \mathbf{0} & 0 \\ \mathbf{0} & \mathbf{0} & \mathbf{P}_{st2} & \mathbf{0} & 0 \\ \mathbf{0} & \mathbf{0} & \mathbf{0} & \mathbf{P}_{st2} & 0 \\ 0 & 0 & 0 & 0 & 1 \end{bmatrix}. \quad (3.39)$$

\mathbf{C}_g is obtained as the stiffness matrix for the dynamic calculation in accordance with section 3.1.4.6. The matrices \mathbf{P}_{sti} are obtained from formula (3.25) and \mathbf{T}_{gs} after (3.17).

The natural frequencies and vibration modes are the solutions of the eigenvalue problem:

$$(\mathbf{C}_t - \lambda_i \mathbf{M}_t) \mathbf{V}_m = \mathbf{0}. \quad (3.40)$$

The λ_i are equal to the square of the natural frequencies of the undamped system: $\lambda_i = \omega_i^2$, the columns of the matrix \mathbf{V}_m contain the eigenvectors or modes of vibration.

3.1.7 Transformation to principal coordinates

The matrix \mathbf{V}_m (also called modal matrix) calculated in section 3.1.6 in accordance with formula (3.40) is equal to the transformation matrix \mathbf{T}_{th} , which is transformed by the inertia principal axes system to principal coordinates:

$$\mathbf{T}_{th} = \mathbf{V}_m. \quad (3.41)$$

With **(3.41)** the following relations for the transformation of the measurement and stiffness matrix as well as the force vector on PCS results:

$$\mathbf{M}_h = \mathbf{T}_{th}^t \mathbf{M}_t \mathbf{T}_{th}, \quad (3.42)$$

$$\mathbf{C}_h = \mathbf{T}_{th}^t \mathbf{C}_t \mathbf{T}_{th} \text{ and} \quad (3.43)$$

$$\mathbf{F}_h = \mathbf{T}_{th}^T \mathbf{T}_{st}^T \mathbf{T}_{gs}^T \mathbf{F}_g, \text{ or} \quad \mathbf{F}_h = \mathbf{T}_{th}^T \mathbf{T}_{st}^T \mathbf{T}_{gs}^T \mathbf{T}_{egi}^T \mathbf{F}_{ei}. \quad (3.44)$$

The ground excitation was defined in centers of gravity coordinates for the one-mass oscillator. This is hardly possible with several rigid bodies. Additionally the ground excitation must no longer work in global z-direction, but can be arbitrarily rotated. Therefore the ground excitation is described first also in element coordinates **(3.46)** whereby the point of attack is situated in the origin of the global coordinate system.

A rotated position (ground excitation does not work in z) is considered by the transformation matrix \mathbf{T}_{ge} with

$$\mathbf{s}_g = \mathbf{T}_{ge} \cdot \mathbf{s}_e \text{ and} \quad (3.45)$$

$$\mathbf{s}_e = [0 \ 0 \ s \ 0 \ 0 \ 0]^T. \quad (3.46)$$

The vector \mathbf{s}_e has the dimension 6. The ground excitation s acts according to standard in z-direction. The vector \mathbf{s}_g has the dimension 13, with which \mathbf{T}_{ge} has the dimension 13x6 and in accordance with **(3.47)** is formed:

$$\mathbf{T}_{ge} = \begin{bmatrix} \mathbf{P}_{eg}^T & \mathbf{0} \\ \mathbf{0} & \mathbf{P}_{eg}^T \\ \mathbf{P}_{eg}^T & \mathbf{0} \\ \mathbf{0} & \mathbf{P}_{eg}^T \\ [\mathbf{P}_{eg}^T]_{3,\bullet} & \mathbf{0} \end{bmatrix}. \quad (3.47)$$

The dimensions of the submatrix in **(3.47)** are shown in **(3.48)**:

$$\mathbf{T}_{ge} [13 \times 6] = \begin{bmatrix} [3 \times 3] & [3 \times 3] \\ [3 \times 3] & [3 \times 3] \\ [3 \times 3] & [3 \times 3] \\ [3 \times 3] & [3 \times 3] \\ [1 \times 3] & [1 \times 3] \end{bmatrix}. \quad (3.48)$$

Since the point of attack of the ground excitation is situated in the origin of the global coordinate system, a translation in \mathbf{T}_{ge} does not need to be considered. Apart from the consideration of the rotation in \mathbf{T}_{ge} at the same time the allocation of the ground

excitation to the coordinates where it has to be considered takes place (for the non-rotated position that are the coordinates z-machine, z-foundation and flexible environment).

If \mathbf{s}_g calculated is after (3.45), the ground excitation can be transformed to principal coordinates:

$$\mathbf{s}_h = \mathbf{T}_{th}^{-1} \mathbf{T}_{st}^{-1} \mathbf{T}_{gs}^{-1} \mathbf{s}_g . \quad (3.49)$$

3.1.8 Consideration of the damping

If any damping coefficients are present, these are given locally for the isolators. The manufacturers of vibration isolators specify the loss angle δ for damping elements. The loss or phase angle is the phase shift between spring and damping force of the element.

ISOMAG uses the Lehr damping factor D . With it material and junction point dampings are often described. It refers likewise to the local effect in the isolators. In the equations of motion the damping coefficient b considers the effect of the damping. The different damping specification can be converted into one another, whereby under (3.50) summarized relations strictly spoken only apply to the one-mass oscillator.

$$\begin{aligned} D &= \frac{1}{2} \tan \delta, \\ b &= 2D\sqrt{c \cdot m} \end{aligned} \quad (3.50)$$

The problem is to find out, how these local dampings in the isolators affect the damping of the complete system.

The eigenvalue solutions of the undamped system are given (cf. section 3.1.6). Thus the system can be transformed to principal coordinates (section 3.1.7) whereby the set of equations is decoupled and one can describe the system by 13 single formulas (single oscillators). That will be used here. After [11] the transformation with the eigenvalue solutions of the undampened system is admissible also for weakly damped systems. Generally in the field of mechanical engineering only material and junction dampings are considered. Then the demand in small damping is generally fulfilled through:

- Small global damping coefficients ($D_{hj} \ll 1$, in mechanical engineering $0.0005 < D_{hj} < 0.15$).
- Low local relative damping at highly stressed points. No couplings by damping forces.

After [11] one can transform the local damping factors \mathbf{D}_e to principal coordinate system using an energy analyses. In [12] similarly with the calculation of local damping coefficients (b_e) will proceed. The algorithms used in **ISOMAG** are represented in the appendix in fig. 7.3.

Thus the damping coefficients for the system, required for the further calculation, in principal coordinates (D_{hj}) and the damping matrices of the isolators \mathbf{B}_{ei} required for the force calculation are known.

The modal damping matrix of the system results in:

$$diag(\mathbf{B}_h)_j = 2 \cdot diag(\mathbf{M}_h)_j \cdot D_{hj} \cdot \omega_j.$$

3.1.9 Frequency response functions

The calculation of the frequency response functions takes place in principal coordinates (PCS). In PCS the system is decoupled and can be treated like 13 one-mass oscillators (cf. section 3.1.7) For the one-mass oscillator the formulas can be written easily (cf. of section 2.1.1 and 2.1.2).

In the next section the calculations for force-, ground- and imbalance excitation are separately represented. If several excitations occur at the same time, the results of the respective calculations are summed up.

3.1.9.1 Force excitation

The forces acting on the system are described by amplitude \hat{F} , circular frequency Ω and the phase shift φ_0 .

A transition to complex values is practical. Similar to formula (2.3) one writes for the variable force F

$$F = \hat{F} \cdot e^{j(\Omega t + \varphi_0)} = \hat{F} \cdot e^{j\varphi_0} \cdot e^{j(\Omega t)} = \tilde{F} \cdot e^{j\Omega t}, \quad (3.51)$$

$$\tilde{F} = \hat{F}(\cos(\varphi_0) + j \sin(\varphi_0)) = \text{Re}(\tilde{F}) + j \text{Im}(\tilde{F}) \quad \text{with}$$

$$\text{Re}(\tilde{F}) = \hat{F} \cos(\varphi_0) \quad \text{and} \quad \text{Im}(\tilde{F}) = \hat{F} \sin(\varphi_0). \quad (3.52)$$

The real force amplitude \hat{F} and the phase angle φ_0 are input in **ISOMAG** at the element. If the coefficients A_i and B_i instead of absolute value and phase shift were input, a coefficient comparison shows that A_i are equal to the real part and B_i are equal to the imaginary part of the complex force. The conversion is done in accordance with formula (3.52).

In order to be able to represent complex forces, a force vector with two columns or a matrix of the dimension 6x2 is required:

$$\tilde{\mathbf{F}} = [\mathbf{Re}(\mathbf{F}), \mathbf{Im}(\mathbf{F})]. \quad (3.53)$$

In **ISOMAG** first at the objects "Force" and "Torque" the harmonic excitations are summarized. Real and imaginary parts are formed and summed separately. For the force acting by default in z-direction we get:

$$\tilde{F}_{ez} = -\sum \tilde{F}_j . \quad (3.54)$$

For the torque around y follows:

$$\tilde{M}_{ey} = \sum \tilde{M}_j . \quad (3.55)$$

For the excitation vectors at the element one finally receives

$$\tilde{\mathbf{F}}_e = [\tilde{0}, \tilde{0}, \tilde{F}_{ez}, \tilde{0}, \tilde{0}, \tilde{0},] \text{ or } \tilde{\mathbf{F}}_e = [\tilde{0}, \tilde{0}, \tilde{0}, \tilde{0}, \tilde{M}_{ey}, \tilde{0},] . \quad (3.56)$$

These excitations are transformed similar to formula (3.44) to the principal coordinate system and overlaid additively there with the harmonic force or torque excitations of other objects:

$$\tilde{\mathbf{F}}_h + = \mathbf{T}_{th}^T \mathbf{T}_{st}^T \mathbf{T}_{gs}^T \mathbf{T}_{egi}^T \tilde{\mathbf{F}}_{ei} , \quad (3.57)$$

whereby the transformation matrices \mathbf{T} are real.

In accordance with the relations stated section 2.1.1 one gets for each component k of the force vector a component k of the displacement vector $\tilde{\mathbf{x}}_h$ according to the following formula:

$$\tilde{x}_{hk} = \frac{\tilde{F}_{hk}}{C_{hkk}} \left[\frac{1 - \eta_k^2}{(1 - \eta_k^2)^2 + 4D_k^2 \eta_k^2} - j \frac{2D_k \eta_k}{(1 - \eta_k^2)^2 + 4D_k^2 \eta_k^2} \right] \text{ with} \quad (3.58)$$

$$\eta_k = \frac{\Omega}{\omega_k} .$$

The displacement \tilde{x}_{hk} is a function of the excitation frequency Ω . In order to achieve this result curve, the formula must be calculated thus for several Ω in the defined frequency range, which can be defined by the user. Ω results after (3.59)

$$\Omega = 2 \cdot \pi \cdot f_{err} \quad (3.59)$$

The displacement in principal coordinates can now be transformed back to any points:

$$\tilde{\mathbf{x}}_e = \mathbf{T}_{eg} \mathbf{T}_{gs} \mathbf{T}_{st} \mathbf{T}_{th} \tilde{\mathbf{x}}_h . \quad (3.60)$$

The complex velocities result in accordance with (2.5) to

$$\dot{\tilde{\mathbf{x}}} = j\Omega \tilde{\mathbf{x}} \quad (3.61)$$

and the acceleration similar to (2.6) to

$$\ddot{\tilde{\mathbf{x}}} = -\Omega^2 \tilde{\mathbf{x}} . \quad (3.62)$$

The formulas **(3.61)** and **(3.62)** apply in any coordinate system (e.g. in principal coordinates or in element coordinates).

The force in the isolators results similar to **(2.11)** too

$$\tilde{\mathbf{F}}_e = \mathbf{C}_e \cdot \tilde{\dot{\mathbf{x}}}_e + \mathbf{B}_e \cdot \tilde{\mathbf{x}}_e . \quad (3.63)$$

If one forms the absolute value for a complex component \tilde{F}_e of the vector, one receives the amplitude characteristic. It can be plotted over the frequency.

3.1.9.2 Ground excitation

The ground excitation is handled similar to section **3.1.9.1**. One finds detailed derivations of the formulas in section **2.1.2**. For the ground excitation the complex quantity \tilde{s}_e is introduced.

The harmonic excitations are summarized also here. For the excitation vector \tilde{s}_e per harmonic j real and imaginary part z-component are formed and separately summed up:

$$\tilde{s}_{ez} = \sum \tilde{s}_j . \quad (3.64)$$

Since there is only one ground excitation, here the summation is omitted over several items. With the transformation on principal coordinates in accordance with **(3.45)** or **(3.49)** one receives:

$$\tilde{\mathbf{s}}_g = \mathbf{T}_{ge} \cdot \tilde{\mathbf{s}}_e \text{ and} \quad (3.65)$$

$$\tilde{\mathbf{s}}_h = \mathbf{T}_{ih}^{-1} \mathbf{T}_{st}^{-1} \mathbf{T}_{gs}^{-1} \tilde{\mathbf{s}}_g . \quad (3.66)$$

For each component k of the exciter vector one receives a component k of the displacement vector similar to **(2.16)** according to the following formula:

$$\tilde{x}_{hk} = \tilde{s}_{hk} \left[\frac{1 - \eta_k^2 + 4D_k^2 \eta_k^2}{(1 - \eta_k^2)^2 + 4D_k^2 \eta_k^2} - j \frac{2D_k \eta_k^3}{(1 - \eta_k^2)^2 + 4D_k^2 \eta_k^2} \right] . \quad (3.67)$$

For the calculation of the velocities, the accelerations and forces the same relations are used like for force excitation (**(3.61)** to **(3.62)**).

If force and ground excitation occur at the same time, the results of both calculations are summed up.

3.1.9.3 Imbalance excitation

An imbalance is treated like two around 90° shifted harmonic force excitations in accordance with **3.1.9.1**. If the axis of rotation of the imbalance coincides with the y-axis (default), the absolute values in z and x-direction of the excitation are equal to the product of the mass m and the distance between axis of rotation and center of gravity r (the product of m and r is often called imbalance U):

$$\begin{aligned}\hat{F}_{z,x} &= m \cdot r \\ &= U\end{aligned}\quad (3.68)$$

φ_{0z} is thereby equal to the input phase angle φ_0 , during φ_{0x} equal $\varphi_0 + 90^\circ$ with clockwise rotation and $\varphi_0 - 90^\circ$ with left hand motion.

The frequency response function for the imbalance excitation results in section **3.1.9.1** multiplied by **(3.68)** calculated frequency response function for the imbalance the U , by the square of the rotating speed Ω .

$$FRF_{ImbalanceExc} = FRF_{Imbalance} \cdot \Omega^2 \quad (3.69)$$

3.1.10 Transmissibility

The transmissibility V is the amplitude response for force and displacement, scaled on 1, in accordance with **3.1.9**. This means, the frequency response functions is divided by its value (i.e $y(\Omega=0)$). With imbalance excitation the first value of the amplitude response of the imbalance times Ω^2 will be used for scaling. Generally (if several excitations exist) frequency response functions for force excitation ($FRFLoad$), ground excitation ($FRFGround$) and imbalance ($FRFImbalance$) can exist. The transmissibility V is calculated therefore as follows:

$$V(\Omega) = \frac{|FRFLoad(\Omega) + FRFGround(\Omega) + FRFImbalance(\Omega) \cdot \Omega^2|}{|FRFLoad(0) + FRFGround(0) + FRFImbalance(0) \cdot \Omega^2|} \quad (3.70)$$

Here the transmissibility of the oscillator with one degree of freedom (and an excitation) is contained in accordance with section **2.1.3** as well as the transmissibilities for individual excitations as a special case.

3.1.11 Time solutions

3.1.11.1 Time solutions for non-harmonic excitation

Time solutions can be calculated by use of convolutions. A time-dependent displacement $x(t)$ due to a force signal $F(t)$ results

$$x(t) = g(t) * F(t), \quad (3.71)$$

where the asterisk is the convolution sign and $g(t)$ the weight function.

A multiplication in the frequency range corresponds to a convolution in the time interval. If one transforms this relationship by Fourier transformation (FFT) into the frequency range (operator $F\{ \}$), one receives the following relationship:

$$F\{x(t)\} = F\{g(t)\} \cdot F\{F(t)\} = X(j\Omega) = G(j\Omega) \cdot F(j\Omega) . \quad (3.72)$$

$G(j\Omega)$ is thereby the transfer function. One receives it for example, if one calculates the frequency response function for an excitation with the amplitude 1 in accordance with section 3.1.9. The excitation with the amplitude 1 acts thereby at the same place and in the same direction as the excitation, for which the time solution is provided. Since the transfer functions can be calculated thus with the algorithms for the frequency response functions, anywhere available in the program, the following procedure is offered: One transforms the exciter signal into the frequency range and multiplies it by the transfer function. One receives the solution in the time interval, by back-transforming the result by inverse FFT into the time interval.

Thus for each exciter element the complex transfer functions \tilde{G}_{ij} are calculated with formula (3.73) for the exciter amplitude 1 according to the frequency solution. j is the index of the coordinate, for which the response or time solution is to be found. Additionally the excitation in the time interval is built point by point according to the specifications. This occurs within a range from 0 to 20.475 s with an increment of 0.005 s, which corresponds to exactly 4096 values. The excitation is transformed by FFT into the frequency range (formula (3.74)) The multiplication of both functions supplies the solution in complex representation (cf. formula (3.75))

$$\tilde{G}_{ij} = \tilde{x}_j (\hat{F}_i = 1) \quad (3.73)$$

$$\tilde{F}_i(j\Omega) = F\{F_i(t)\} \quad (3.74)$$

$$\tilde{x}_j = \tilde{G}_{ij} \cdot \tilde{F}_i \quad (3.75)$$

For the ground excitation as well as the calculation of the forces one forms suitable transfer functions and proceeds similarly. If several excitations exist the calculations (3.73) are to be executed for each excitation. The total solution \tilde{x}_j results from the total of the single solutions. So that the overlay can take place correctly according to phase, the summation must take place in complex plane.

Velocities and acceleration result again in:

$$\dot{\tilde{x}} = j\Omega\tilde{x} , \quad \text{or} \quad (3.76)$$

$$\ddot{\tilde{x}} = -\Omega^2\tilde{x} . \quad (3.77)$$

The time solution is equal to the real part of the inverse FFT (the imaginary part is zero). The velocity over time is then:

$$v(t) = \text{Re}\left(\mathbb{F}^{-1}\left\{\dot{\tilde{x}}\right\}\right). \quad (3.78)$$

3.1.11.2 Time solutions for harmonic excitation

One can always determine all time solutions as described before. Thus the exciter functions can be completely arbitrary (also harmonic). However the transient response (initial values: $v = 0$ and $x = 0$) is included in the results, which does not correspond to the steady state. If no damping is available, initial disturbances do not decay, and the steady state is never reached.

The calculation is executed for each given harmonic Ω_k exciter frequency (for a given constant harmonic excitation is $\Omega_k = 0$).

The transfer function is formed **(3.73)** for $\Omega = \Omega_k$:

$$\tilde{G}_{ij} = \tilde{x}_j(\hat{F}_i = 1, \Omega = \Omega_k), \quad (3.79)$$

i.e., for a given exciter frequency Ω_k one receives a complex solution (the transfer function has only one complex value).

The considered harmonic excitation k is transformed to the complex plane. This can be done here without Fourier transformation. A coefficient comparison shows:

$$\text{Re}(\tilde{F}_k) = A_k, \quad \text{Im}(\tilde{F}_k) = B_k. \quad (3.80)$$

A_k and B_k are the coefficients for cosine or sine part, input in the program for the excitation. The complex displacement with force excitation results similarly to formula **(3.75)** too:

$$\tilde{x}_{jk} = \tilde{G}_{ij} \cdot \tilde{F}_{ik}. \quad (3.81)$$

The back calculation into the time domain can be done again by coefficient comparison:

$$A_{jk} = \text{Re}(\tilde{x}_{jk}), \quad B_{jk} = \text{Im}(\tilde{x}_{jk}). \quad (3.82)$$

The time solution arises finally as a result of summation of each harmonic k :

$$x_j(t) = \sum_k A_{jk} \cos(\Omega_k t) + B_{jk} \sin(\Omega_k t), \text{ with } t = 0 \dots t_{END}. \quad (3.83)$$

Velocities and accelerations occur again in accordance with **(3.76)** or **(3.77)**. In the time domain applies then:

$$v_j(t) = \sum_k A_{jk} \cos(\Omega_k t) + B_{jk} \sin(\Omega_k t), \text{ with } A_{jk} = \text{Re}(\dot{\tilde{x}}_{jk}), \text{ and } B_{jk} = \text{Im}(\dot{\tilde{x}}_{jk}) \text{ or} \quad (3.84)$$

$$a_j(t) = \sum_k A_{jk} \cos(\Omega_k t) + B_{jk} \sin(\Omega_k t), \text{ with } A_{jk} = \text{Re}(\tilde{\tilde{x}}_{jk}), \text{ and } B_{jk} = \text{Im}(\tilde{\tilde{x}}_{jk}). \quad (3.85)$$

The ground excitation is handled similarly.

3.1.11.3 Imbalance

An imbalance is treated like two around 90° shifted harmonic excitations in accordance with **3.1.11.2**. If the axis of rotation of the imbalance coincides with the y-axis (default), the absolute values in z and x-direction of the excitation are equal to the product of the mass m and the distance between axis of rotation and center of gravity r (the product of m and r is often called imbalance):

$$\hat{F}_{z,x} = m \cdot r \cdot \Omega^2. \quad (3.86)$$

φ_{0z} is thereby equal to the input phase angle φ_0 , while φ_{0x} is $\varphi_0 + 90^\circ$.

With clockwise rotation both forces rotate with $+\Omega$, and vice versa.

3.1.12 Dimensioning calculation

Apart from the dynamic analysis of the modeled system (revision calculation) **ISO-MAG** supports the user also with the search for suitable isolators. Required stiffness and loads which are to be carried are determined. Suitable isolators in the database can be found with these quantities (section **3.2**).

The dimensioning calculation serves for the preselection of isolators and always takes place for minimum models with only one coordinate direction (usually z). To what extent the assumption for this system can be transferred is shown in the revision calculation. Sometimes stiffness and inertia are to be varied, in order to achieve the desired degree of isolation in the system with up to 13 degrees of freedom.

3.1.12.1 Calculation of the required stiffness for the simple vibration isolation

The calculation of the required stiffness for the simple vibration isolation corresponds as far as possible, to that which the manufacturers recommend in their catalogues.

For simple vibration isolation the required stiffness for the oscillator with one degree of freedom is calculated. Frequently the foundation is made symmetrically. Thus equations of motion are decoupled and one can apply these formulas separately for different degrees of freedom for dimensioning of isolators. With symmetry to the x-z and y-z-plane one receives decoupled formulas for the translation in z and for the rotation around z (cf. **[19]**). If one succeeds in bringing center of gravity and spring center (in accordance with **3.1.4.5** and **3.1.4.4**) in z-direction (e.g. with deep position of the center of gravity and hanging foundation), then all degrees of freedom can be decoupled.

In practice frequently only the z-direction of the oscillator is considered. The system is dimensioned in reference to z, independently of whether it is decoupled or not and without attention to the further frequencies. In the program the oscillator with one de-

degree of freedom is used only for preselection (dimensioning) of isolators. All further calculations (revision) consider the complete oscillator with up to 13 degrees of freedom.

For the calculation of the required stiffness the following data is needed:

- the minimum exciter frequency $f_{err\min}$,
- the desired tuning ratio av or the desired degree of isolation i ,
- the mass of the system m_{ausl} as well as
- the number of used isolators n_{fdausl} , so that the required stiffness per isolator can be determined (equal stiffness and load presupposed).

These quantities can be input. Once started with the model description, ISOMAG uses the values of the machine for the oscillator with one degree of freedom in z-direction as default.

The following formulas lead by the natural frequency of the oscillator with one degree of freedom f_{eig1fg} to the required stiffness of the installation elements c_{erfe} :

$$f_{eig1fg} = f_{err\min} / av \text{ or}$$

$$f_{eig1fg} = f_{err\min} \sqrt{\frac{i-1}{i-2}} \quad (3.87)$$

$$c_{erfges} = m_{ausl} (2\pi f_{eig1fg})^2 \text{ and} \quad (3.88)$$

$$c_{erfe} = \frac{c_{erfges}}{n_{fdausl}}. \quad (3.89)$$

The force in the installation element, relevant for the dimensioning, results in:

$$F_{eausl} = \frac{m_{ausl} \cdot g + F_{statz}}{n_{fdausl}}. \quad (3.90)$$

With F_{statz} all static and constant forces or force components in z-direction are considered.

In such a way determined values for the required stiffness and load of the items correspond to those, which one receives also according to the calculation algorithms suggested by the manufacturers. During the force determination it is assumed all installation elements are symmetrical by the weight of the mass m_{ausl} loaded. This does not need to be the case. Additional outside static forces can result. If more exact values are known, these can be input explicitly.

3.1.12.2 Stiffness and mass of foundation for the double vibration isolation

The dimensioning calculation is done for the two-mass oscillator (**fig. 2.3**) and deep tuning. One assumes m_1 and c_1 are already fixed. This is the case, for example, if one exploited the possibilities of the simple vibration isolation before.

The foundation mass should be as high as possible after **2.1.1**. In practice values from five to twenty times of the machine mass are usual. Still if no foundation is available, the program suggests a foundation with adapted geometry. The user can modify the foundation mass if necessary, e.g. by variation of geometry or density.

The stiffness remains c_2 , i.e. those of the isolators between foundation and environment as a value which can be designed.

With

$$i = 1 - V \quad (3.91)$$

and **(2.28)**, **(2.26)** and **(2.21)** results:

$$c_2 = \frac{c_1 \cdot (1 - i) \cdot \left(\frac{m_2}{m_1} \cdot (\eta^2 - 1) - 1 \right)}{1 - i \cdot \left(1 - \frac{1}{\eta^2} \right)}. \quad (3.92)$$

(3.92) supplies practically useful values only for $\eta > 1$. Additionally it is to be noted that η is here not as with the one-mass oscillator a measure for the distance of the frequencies (tuning ratio), but rather a figure:

$$\eta = \Omega \cdot \sqrt{\frac{m_1}{c_1}}. \quad (3.93)$$

After section **2.3** the term of the tuning ratio is not unique with the two-mass oscillator. Therefore one operates here with the degree of isolation as measure for the vibration isolation.

In ISOMAG for c_1 an element of the global stiffness matrix is used:

$$c_1 = [\mathbf{C}_g]_{3,3} \quad (3.94)$$

With **(3.94)** all stiffness components working in z-direction at the machine are considered. Stiffnesses, which do not work between machine and foundation, falsify the dimensioning. In addition, the result is not correct, if these stiffnesses from c_1 are counted out. It concerns only a dimensioning here. The revision calculation brings final results. If necessary, stiffness between machine and environment can be eliminated by the user in the model during the dimensioning calculation. Stiffness between machine and environment are modeled rarely anyway.

3.2 Database connection

3.2.1 Target and request

Providing a digital catalogue of isolators is one of the key features of **ISOMAG**. It allows the user to quickly search for suitable isolators and use them including their parameters with only one mouse click. It also offers the possibility to order and compare Isolators of different providers.

In order to use an Isolator with ISOMAG a basic set of parameters is needed, which can be found in the manufacturer's data. Since different manufacturers do not describe their products in a uniform way, several catalogues ([19] to [23]) have been analyzed to find those parameters which are given in a similar way and ways to convert parameters which are not. The standards [17] and [18] helped to decide which information should be held in the database.

Apart from the parameters which are required for the calculation there are other things kept by the database: metadata for displaying the database content properly, dimension information for construction purposes and manufacturer contact information.

ISOMAG uses the Microsoft SQL Server Compact database format (SDF).

3.2.2 Database structure

The database used by ISOMAG contains several tables which are related to each other. The most important information is kept in the tables "Hersteller", "IsoHaupt", "F-s-Kennlinie" and "Grenzwerte".

"Hersteller" contains data about the different manufacturers, whereas "IsoHaupt" contains the isolators. Each isolator holds a reference to the corresponding manufacturer (cf. **fig. 3.7**).

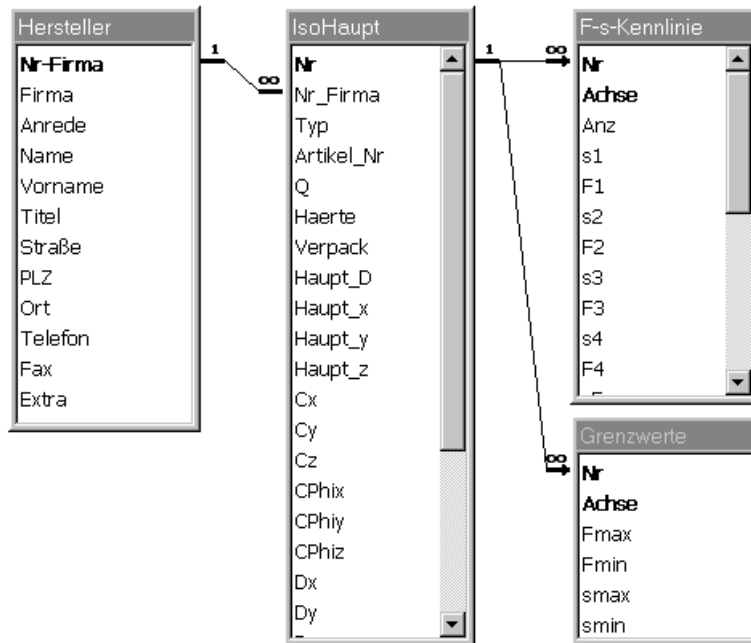

fig. 3.7 ISOMAG database structure

Limiting values for spring range and -force of an isolator are described in the table “Grenzwerte”. Each record is connected to an axis of an isolator. That is the same for the table “F-s-Kennlinie”, which holds a characteristic curve of an isolatoraxis to describe nonlinear behavior with up to 10 points.

Contents of these two tables are optional and depend on the corresponding isolator. Axes are defined using ‘x’, ‘y’ and ‘z’. It is possible to describe limits and/or behavior for more axes at once if they are identical. In that case use a combination like ‘xy’.

There are additional tables holding metadata used by ISOMAG. They should not be changed in any way, but can be used to, for example, find out which unit is used for the values in one of the other tables. When record sets are added to one of the tables “Hersteller”, “IsoHaupt”, “F-s-Kennlinie” and/or “Grenzwerte” values should be given in the correct unit.

The tables “Federn” and “Federn_mit_Hersteller” are generated and filled by ISOMAG automatically. They are not supposed to receive new records.

4 Program description

4.1 Hard and software requirements

ISOMAG is a 32 bit Application. It runs under all versions of Windows above XP.

The used 3D graphics needs much computation power, especially for larger models or imported CAD bodies. Thus a computer with 3D hardware acceleration should be used.

4.2 Scope and field of application

Main field of the program is the calculation and dimensioning of vibration-isolated location of machines and devices. The location takes place on flexible items - the isolators - and is possible with or without foundation.

The program **ISOMAG** calculates the dynamic behavior of two rigid bodies, which are flexibly connected and flexibly supported against an environment. The environment can be assumed as rigid or elastically.

Each rigid body has six degrees of freedom. It is distinguished by the fact that the displacements are substantially smaller in its inside than the movements, which it executes due to the flexible support against other bodies or its environment. Rigid bodies are for example a machine, an engine block or a rigid unit in itself (inclusive foundation, if this is rigidly connected). With flexible coupling the rigid foundation (block foundation) forms the second body.

If one additionally assumes the environment as flexible in vertical direction, then altogether 13 degrees of freedom ($2 \times 6 + 1$) are to be considered.

By flexible support one understands the flexible effect of installation elements, isolators or additional springs, e.g. pipe connections. Weak damping - the material damping of the flexible items - can be considered likewise. The parameters of the installation elements can be taken from the connected database.

During the calculations all 13 degrees of freedom are considered. Thus one does not only receive all (up to 13) interesting natural frequencies and vibration modes. Also no conditions are to be fulfilled concerning the decoupling of individual degrees of freedom. Oscillators with one or two degrees of freedom and planar models are contained as special cases.

The excitation can take place via constant, harmonic and transient forces (force excitation) or via harmonic and transient movement of the environment (ground excitation). Thus both functions of the vibration isolation of machines and of devices can be treated in accordance with **fig. 1.1** with **ISOMAG**. Additionally time and frequency solutions can be calculated for imbalance excitations. If several excitations work at the same time, an overlay supplies the actual stresses (and not the unrealistic total of

the maximum values). The output of the sum forces on the base permit a rapid evaluation of the effectiveness of the vibration isolation.

The user interacts through a graphical user interface. Model, inputs and results are represented numerically and graphically.

In detail the program executes the following calculations:

- For one or two a rigid body (machine and foundation) consisting of geometrically elementary basic bodies (cuboids, hollow cylinders, prisms, spheres, general mass as well as moment of inertia) the inertia properties are calculated. These are the position of the center of gravity, the mass, the principal moments of inertia and the directions of the principal inertia axes. The calculation takes place for each body separately as well as for both bodies simultaneously. The individual basic bodies can be in any positions to each other and be arbitrarily rotated or translated.
- For as many as desired isolators - whose stiffness can also be nonlinear - the stiffness properties are determined. These are the values and directions of the principal translatory stiffness as well as the position of the center of elasticity (if this exists). The calculation takes place for all isolators present on the machine (rigid body 1) and all within the foundation (rigid body 2) **and not with the machine** connected isolators. These results enable it to align horizontally the machine loaded by the weight.
- The dimensioning calculation (corresponding to the regulations of the manufacturers) for the simple vibration isolation, a wizard for the double vibration isolation and the database connection with various search functions support the user in selection of suitable isolators.
- The static displacements in the installation elements and in any points of the system are calculated. Additionally one receives the static loads of the installation elements and the total of the static loads at points. The observance of limiting values concerning stress and strain is monitored. The system is checked for static determinateness.
- **ISOMAG** calculates the natural frequencies and modes of motion.
- Amplitude responses and transmissibilities for force and displacement with harmonic excitations (force and ground excitation) as well as imbalance excitation are calculated and represented over the frequency. The values of the forces in the isolators as well as displacement, velocity and acceleration at any points can be determined for harmonic, transient as well as imbalance excitation. The various evaluation possibilities in the result windows permit, the check of the achieved degree of isolation and the calculation of max. -, mean- or RMS- values. The different, also multiple force or torque- and imbalance excitations can be in any positions and be arbitrarily oriented in the space. The ground excitation represents a movement of the environment /installing area in arbitrary direction. The material damping (weak damping) can be considered.

- Static displacements, natural and operation vibration modes can be animated.
- The total of the forces on the ground - correct according to phase or according to absolute value - are available as output quantities. The amount/amplitudes of the movement of points in the space are calculated.

Following assumptions are made in the algorithms of **ISOMAG**:

- small vibration displacement amplitudes and displacements (small in relation to the geometrical dimensions of the rigid bodies),
- ideally rigid body,
- massless springs,
- linear spring characteristic around the operating point (static equilibrium position),
- rigidity of the ground in horizontal direction as well as
- small damping ($D < 0,15$).

4.2.1 Limitations

The results of the time and frequency domain computations represent the behavior of the system in steady state linearized at the operating point. The operating point is determined by the settling of the system caused by its own weight and static loads.

This procedure is excellent for standard tasks of vibration isolation. However, there are restrictions, which are described, in the following chapters.

4.2.1.1 Springs with non-linear force/displacement curve

Elastomer springs usually have a progressive spring characteristic. This characteristic can be input point by point in the parameter dialog of the isolators. In the calculation of the static displacement these nonlinearities are taken into account correctly. All computations after the eigenfrequency analysis the stiffnesses are taken from the tangents of the characteristic curves at the operating point. Hence the stiffnesses are constant for all calculations in the frequency range and time domain and they are independent from the displacements.

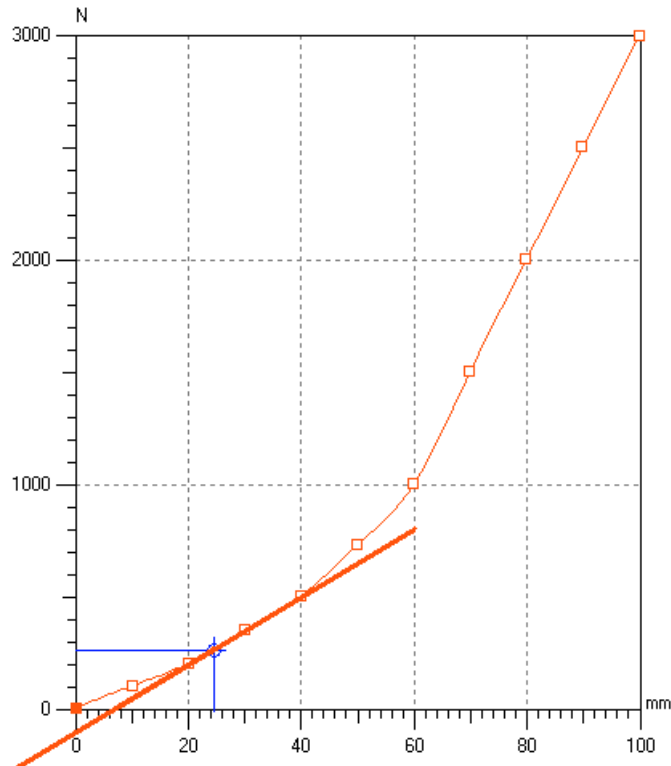

fig. 4.1 Force/displacement curve with tangent at the operating point

For small displacements (common for vibration isolation) this error can be neglected. For large displacements differences may occur.

To model the following effects, this procedure is not suitable though:

- Modeling of elastic end stops or bumper springs (any springs considered are permanently in contact).
- Springs with different behavior when under tension and compressed (e.g. ropes, contacts)

4.2.1.2 Large Distorsion

For calculating the transfer function of the system, a linear system is assumed. However, our system is approximately linear only for small angles as long as:

$$\begin{aligned} \cos(\varphi) &\approx 1 \\ \sin(\varphi) &\approx 0 \end{aligned} \tag{4.1}$$

can be applied. For machines, which are designed in a vibration-isolated manner, the distortions are mostly only few degrees. Hence the assumptions ought to be fulfilled.

4.2.1.3 Pulses and other non-periodic excitations

Any time signals which are submitted to FFT, are assumed to be periodic (length of signal is equal to period length). This equally applies to pulses and user-defined excitations. Therefore, if only a single pulse excitation is to be considered, the length of the time signal should be much greater than the pulse width. Due to the damping, the system vibration can decay during the pulse break and multiple excitations are avoided.

In the case of user-defined excitations you should add to the curve of interest a sufficiently long period without an excitation during which the system vibration is allowed to decay.

An analogous statement can be made for ground excitation if you define a velocity or acceleration where the pertinent displacement (single or double integration over time) will not be zero at the end. In that case the system is already in its displaced state at the beginning which will result in an offset in the results over time.

4.3 General operational sequence

The general program sequence is shown in **fig. 7.4** to **fig. 7.7** in the annex.

In order to install a machine in a vibration-isolated manner simple vibration isolation is tried first. If no suitable isolators (by quantity, arrangement and parameters) are to be found and also the attachment of additional masses (e.g. a rigidly coupled foundation) does not bring any effect, double vibration isolation can be tried. This exploits to the results of the simple isolation, by placing as the simple installed object on a flexibly mounted foundation (for the theory cf. section **2.2**).

First the inertia properties of the object which is to be isolated (machine) have to be described. Therefore the complete body can be assembled from several sub bodies.

Subsequently, one states position and quantity of installation elements (for the easy isolation). If necessary, the isolators can be aligned in such a way that their center of elasticity coincides with the center of mass. In order to install the machine horizontally, one principal stiffness should be oriented in z-direction and go through the center of mass of the machine.

The wizard for the simple vibration isolation allows a preselection of suitable isolators. The wizard determines the required stiffness and the load of the isolators according to the oscillator with one degree of freedom. For this the desired degree of isolation and the minimum excitation frequency have to be given, if excitations were not defined yet. With the values for stiffness and load **ISOMAG** searches in the database for suitable installation elements. If necessary the selection can be refined with modified or additional search criteria. If the search was not successful, the mass or the quantity as well as the position of isolators can be varied.

The parameters of the selected isolators can be imported into the program. After the (static) loads are defined, the static displacements and internal loads at the isolators are determined. For the resulting operating point (static equilibrium position) the complete stiffness matrix is formulated. Additionally the program checks the adherence to the static limit values as well as the static determinateness of the system.

If necessary the position of the installation elements can be varied again, in order to eliminate the static tilt of the foundation.

The six natural frequencies and vibration modes for the undamped system are calculated.

In the calculation of the amplitude responses and the time functions the damping is taken into account. The amplitude response and the transmissibility can be plotted for different coordinate directions. Entering the required degree of isolation and the excitation frequencies into the transmissibility plot one can check whether the degree of isolation is reached. To evaluate the isolating effect, the total of the forces on the ground can be used also.

The displacements, velocities, and accelerations at defined points, caused by the defined excitations, as well as forces in the installation elements can be displayed as time functions. Relevant values for the vibration evaluation (minimum, maximum, mean, and RMS value) are determined for the displayed quantities. They can be plotted into the result windows.

Finally, the natural mode shapes and the vibration shapes can be displayed over geometry (animated). This shows rapidly, which components significantly influences which frequency.

Modifications are possible in all parts at any time. Thus one can arrange the system in such a way, that it shows the desired behavior.

With the double vibration isolation the degree of isolation can still be improved in the deep tuning state. If for an already deep tuned system (all natural frequencies are lower than the excitation frequencies) the desired degree of isolation is not achieved with a simple isolation, the degree of isolation may be achieved with a double vibration isolation. The wizard for double vibration isolation assists in achieving this goal. If not defined yet it suggests a foundation and an arrangement of isolators. Load and required stiffness of the foundation isolators in z-direction are determined. From the database one can select suitable isolators. If necessary foundation geometry and density as well as quantity and arrangement of isolators can be determined or modified at the model.

If foundation and foundation isolators are already available in the model, the wizard for double vibration isolation allows the selection of foundation isolators with suitable stiffness and load capacity in z-direction.

If the elasticity of the installation place cannot be neglected, the characteristics of the environment (inertia and stiffness or frequency) in vertical direction can be considered.

4.4 The graphical user interface

The worksheet is used for the description of the models (**fig. 4.2**). By default it is divided into four views. With the *object bar* in the left section you can create objects. The *tree view* on the right reflects the object hierarchy. Section 4.4.4 describes the individual functions of the menu bar. Some menu options are rapidly attainable by buttons of the toolbar (section 4.4.5). If one moves the cursor on a symbol, after short time a tool tip appears with a note to the function.

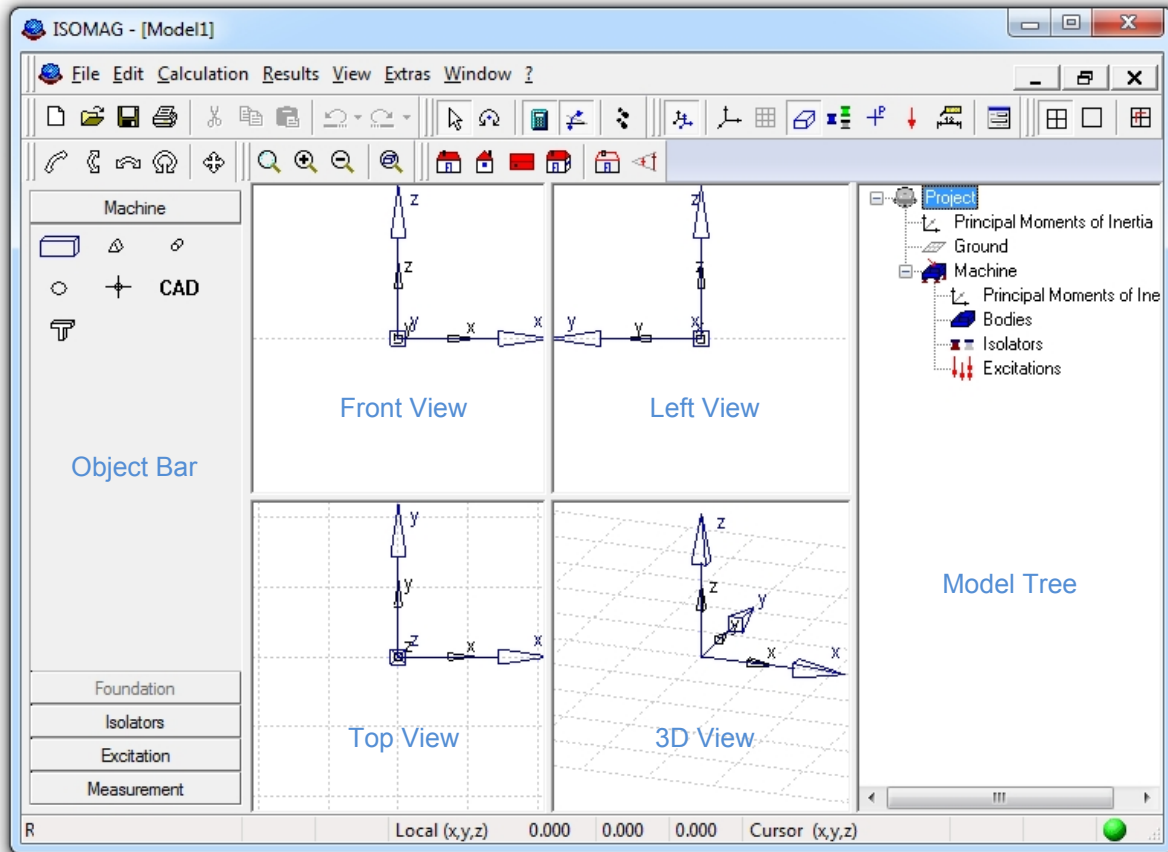

fig. 4.2 The ISOMAG graphical user interface

The status line at the lower edge shows the current status of the program as well as different coordinates (section 4.4.6) The colored ball on the right gives information whether the calculation results are current (green) or not (red).

Object hierarchy: A project contains generally a large set of different objects (bodies, isolators, excitations...). They are hierarchically arranged according to their function or affiliation (cf. section 4.6). The description of the objects position always refers to the respective parent object (**fig. 4.3**).

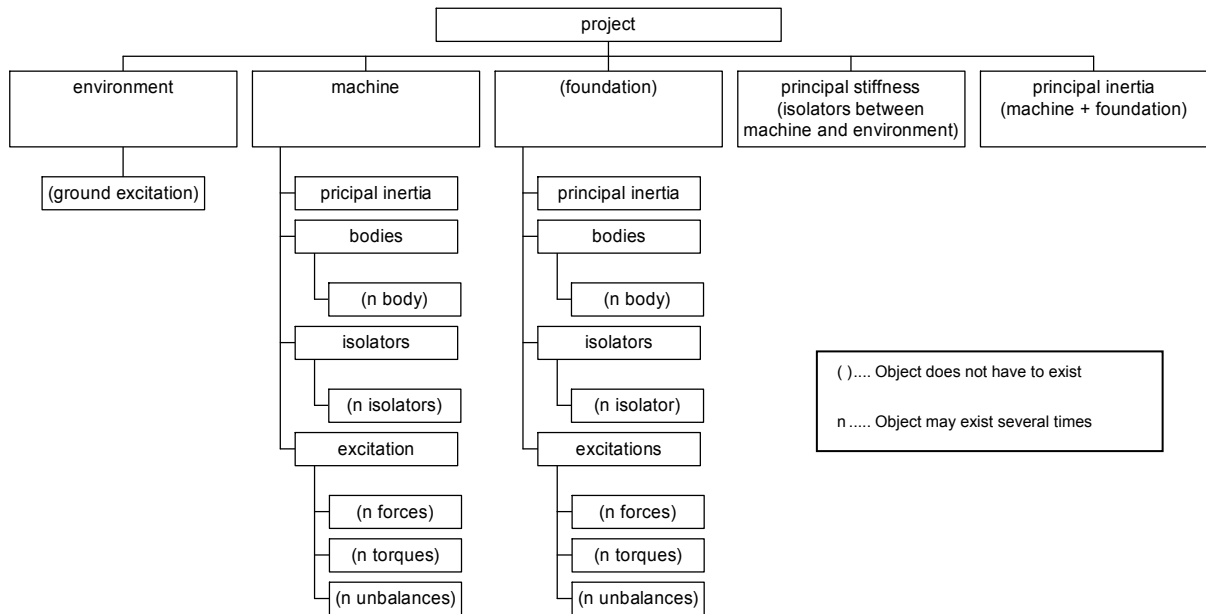

fig. 4.3 Object hierarchy

4.4.1 Worksheet

The model can be shown on the worksheet two as well as three-dimensional. The representation in four windows (front, side, and top view, as well as 3D-view) is defined as standard. Each window can have any size. With the buttons and one switches between the four-window and the one-window mode. By default the latter one is the 3D window, but it can be modified with , , and into one of the 2D-views. With the views are aligned and the scale is selected in such a way, that the complete model becomes visible.















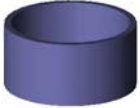

Within the 2D-views you can manipulate the zoom factor and the visible section. If the mouse pointer is within one of the 2D-views, the status line displays the current coordinates. With cursor keys selected objects can be moved by one grid point. New objects can be created only in these views. Measurements are shown in the 2D-view, in which they were created.

Special feature of the 3D-views: With one can switch between parallel projection and perspective projection. With one of the buttons , , , or by means of the keys R, X, Y, Z you activate on one of the rotation modes. If you click into the 3D-view and move the cursor with the left mouse button pressed the view rotates accordingly.

4.4.2 Object bar

The *object bar* in the left part of the program window (**fig. 4.2**) contains all bodies for the model creation. If one actuates one of the buttons, the available objects become visible (cf. **Table 4.1**). After you click one of the object buttons you can place the object on the worksheet (into one of the 2D-views) (cf. section 4.5).

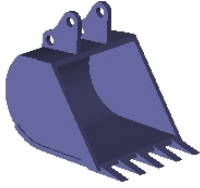
Table 4.1 Outline of all ISOMAG model objects

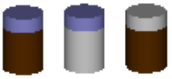
	Object	Symbol	Works on	Remark
	Machine			<ul style="list-style-type: none"> - always existing - invisible by default
	Intermediate foundation			<ul style="list-style-type: none"> - is created with the generation of the first foundation structure - invisible by default
	Ground			<ul style="list-style-type: none"> - modeling of the floor - rigidly or flexibly - is always existing
	Block		<ul style="list-style-type: none"> - Machine - Foundation 	
	Prism		<ul style="list-style-type: none"> - Machine - Foundation 	
	Cylinder		<ul style="list-style-type: none"> - Machine - Foundation 	
	Sphere		<ul style="list-style-type: none"> - Machine - Foundation 	
	Free Prism		<ul style="list-style-type: none"> - Machine - Foundation 	
	CAD Import		<ul style="list-style-type: none"> - Machine - Foundation 	
	Isolator		<ul style="list-style-type: none"> - Machine - Foundation 	<ul style="list-style-type: none"> - between machine / ground - between machine / foundation - between foundation / ground









Object		Symbol	Works on	Remark
	Force		<ul style="list-style-type: none"> - Machine - Foundation 	
	Torque		<ul style="list-style-type: none"> - Machine - Foundation 	
	Imbalance		<ul style="list-style-type: none"> - Machine - Foundation 	
	Ground excitation		<ul style="list-style-type: none"> - Ground 	<ul style="list-style-type: none"> - exists only once - movement of ground in arbitrary direction

Table 4.2 Objects, which supply results of the calculation









Object		Symbol	Works on	Remark
	Isolator		<ul style="list-style-type: none"> - Machine - Foundation 	<ul style="list-style-type: none"> - Loads - Displacements
	Ground			<ul style="list-style-type: none"> - Total load
	Point		<ul style="list-style-type: none"> - Machine - Foundation 	<ul style="list-style-type: none"> - Quantities of motion
	Principal moments of inertia		<ul style="list-style-type: none"> - Project - Machine - Foundation 	<ul style="list-style-type: none"> - Center of gravity - Position of the inertia principal axes - always existing
	Principal stiffness		<ul style="list-style-type: none"> - Project 	<ul style="list-style-type: none"> - Elastic center - Position of the stiffness principal axes at machine or foundation - always existing

Table 4.3 Objects for additional information

Object		Symbol	Remark
	Measure		<ul style="list-style-type: none"> - only visible in the view, in which it was created
	Label		

4.4.3 Tree view

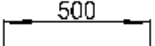
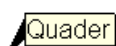
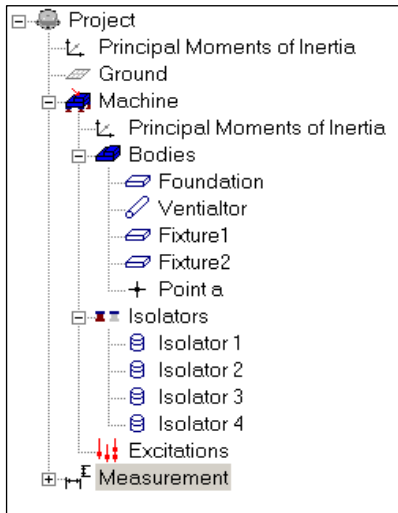

The *tree view* at the right of the program window shows the complete structure of the respective project and serves for fast navigation. The individual entries are the names of the objects.

Similar to the Windows Explorer a branch through mouse-clicks on the " + " or " - " symbol is shown or hidden. The presence of these symbols indicates an object to be parent for further objects. Objects can be renamed (click on the names), labeled and edited (doubleclick or right mouse button) here. Detailed explanations on this can be found in the section 4.5.

4.4.4 Menu Bar

This section briefly describes the **ISOMAG** menu commands. The menu commands belonging to the Windows standard menus are not described here. Please consult suitable manuals and the on-line help for explanations. Via  (as well as the F1-key) one reaches the **ISOMAG** help. Some of the following instructions can be executed via context menu (right mouse button) too.

4.4.4.1 File menu

The file menu contains the menu options for creation, opening, closing, saving, and printing of the models.

4.4.4.2 Edit menu

Selected objects can be duplicated via the Clipboard and thus can be exchanged between different projects. The following short cuts execute these functions:

- "Shift+Del " cuts selected **ISOMAG** objects out of the structure and copies them into the Clipboard,
- "Ctrl+C " copies selected objects into the Clipboard,
- "Ctrl+V " inserts objects from the Clipboard into the structure.

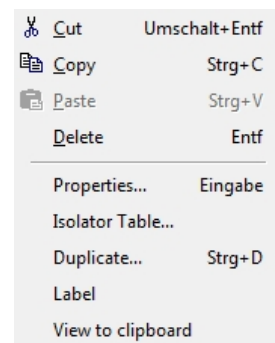

If the foundation is selected when inserting objects, the objects are assigned to the foundation, otherwise they are assigned to the machine. Thus there is the possibility to assign objects to the foundation, which erroneously were assigned to the machine before.

"**Properties...**" opens the parameter dialog for the selected objects (also possible via the context menu); see also the description of the individual objects in section 4.6.

"**Isolator Table...**" opens the isolators list of the current model. More information can be found in section 4.6.5.

Via "**Duplicate...**" or "Ctrl+D" selected objects can be multiply duplicated. In the dialog (fig. 4.4) one indicates the number of copies as well as their displacement. The new objects automatically obtain a unique name, which consists of the name for the respective original object extended by a number.

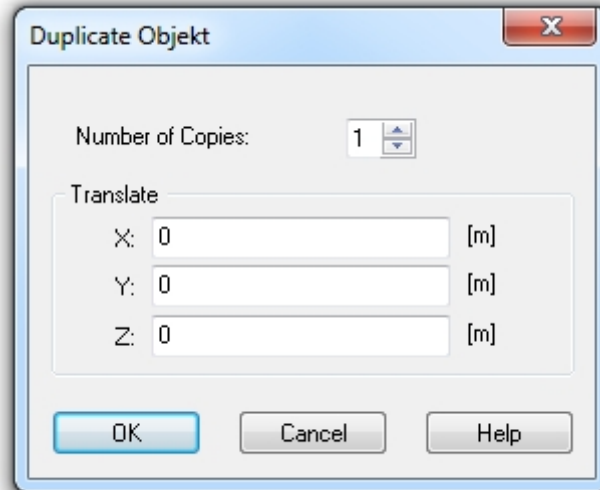

fig. 4.4 Dialog window for duplicating objects

"**Labels**" are switched on/off over the menu option "Edit/Label" or via the context menu. If several objects are selected, the instruction is applied to all of them. The position can be changed by clicking on the text and dragging it. The dragging affects all views. Detailed explanations are found in section 4.5.4.4.

The command "View to Clipboard" generates an image of the current 3D-view(s) and copies it to the clipboard. It can be inserted into any other Windows application. In order to ensure a high quality, the resolution of this image is higher than the current screen resolution.

4.4.4.3 Calculation menu

With this menu option the wizards for the simple and the double vibration isolation can be started. They help the user to select suitable isolators.

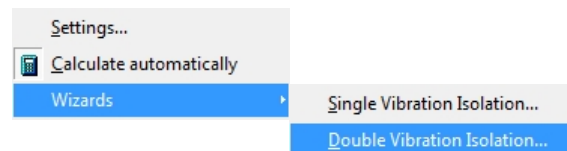

By default the calculation is restarted after each modification in the model. If the calculation cannot be finished successfully, a message appears. In this case the title bar of all result windows displays "- not up-to-date -" is displayed. The ball in the status line remains red. The displayed results are those of the last successful calculation run. The automatic calculation can be deactivated with the button . This is recom-



mended in particular if the model is still in creation. Then a new calculation is then only executed if a new result is to be displayed or the animation is started (cf. section 4.7).

"Settings..." opens the dialog for the calculation settings (see section 4.7.1).

4.4.4.4 Results menu

Some selected results - principal moments of inertia, stiffness, and natural frequencies - can be displayed with this menu option. One obtains further results with the context menu. For a detailed description refer to paragraphs 4.8 and 5.3.

4.4.4.5 View menu

As already described in 4.4.1 you can change here between the four and the one window mode. Also the views can be aligned in such a way that the complete model is visible. The buttons ,  and  are also found in the Toolbar.

4.4.4.6 Extra menu

Physical units can be changed using the dialog "Physical Units" ("**Extras/Units...**"). In order to modify a physical unit, one clicks into the corresponding line and selects the desired unit from the listbox (fig. 4.5). All quantities in the model are then converted into the new unit. All following inputs take place in the new unit.

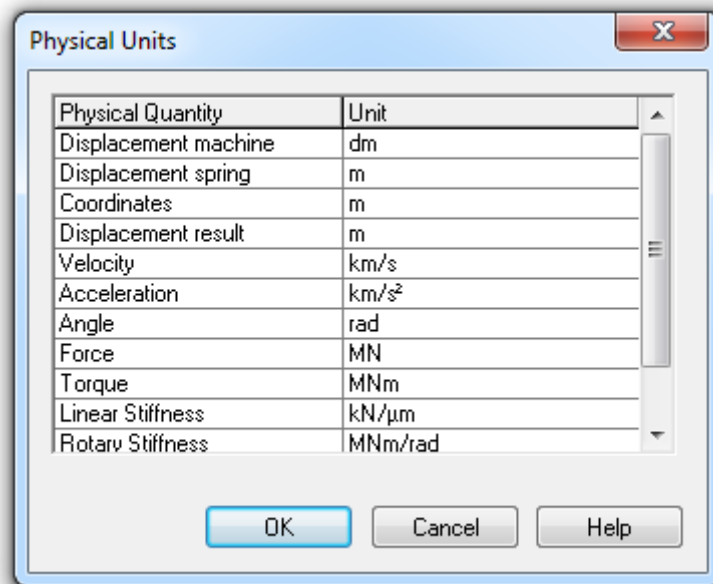

fig. 4.5 Units

Under "**Project Settings...**" you can provide the project with further information (fig. 4.6).

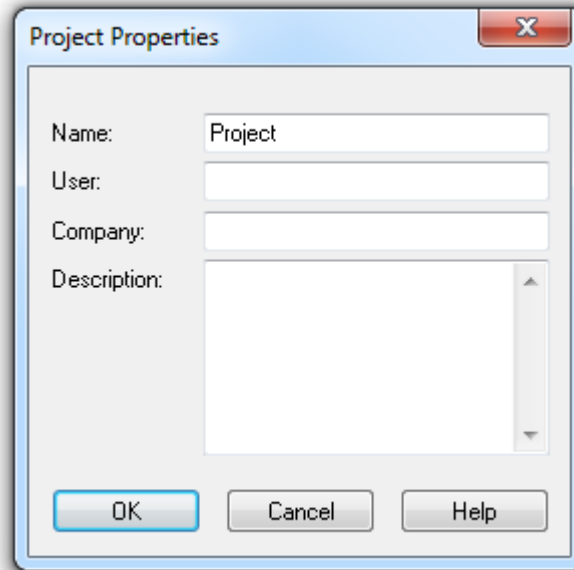

fig. 4.6 Project settings

Under the menu option "**Settings...**" the colors of the worksheet background, the edges of selected objects, and the global coordinate system (GCS) can be changed. The grid adjustments serve as a positioning help for graphically-interactive dragging and rotations.

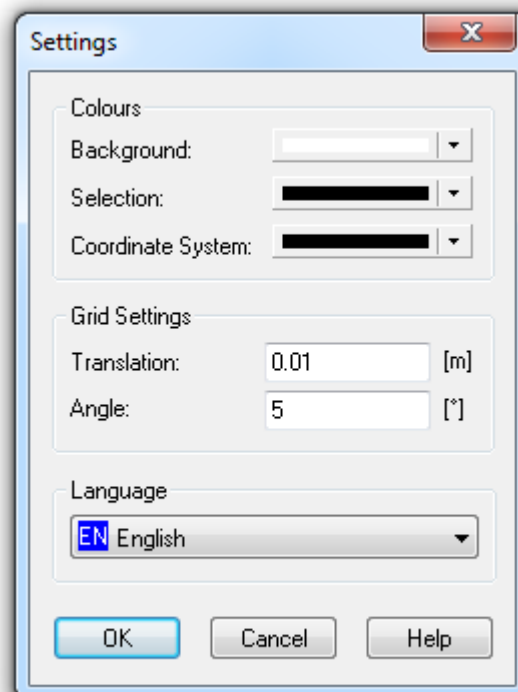



















Fig. 4.7 Basic settings

"**Isolators Defaults...**" opens a dialog which is similar to the properties dialog of isolators. The parameter values of this dialog are used as default values for new isolators. The values can for example be changed in order use a certain stiffness for new isolators. The parameters values can be reset their delivery states by pressing the "Reset" button.

4.4.4.7 Window menu

The menu "**New Window**" creates a copy of all views. The instruction "**Cascade**" allocates the open windows in such a way that all title bars are visible, while with "**Tile horizontally**" all windows are to be seen complete.

4.4.5 **Toolbar**

The Toolbars are located below the menu bar (**fig. 4.2**). The help quickly execute frequently needed commands. Some of these operations are also available via menus or shortcuts. Buttons, which do not correspond to menu instruction, are described in **Table 7.3**. This includes the instruction "**Select and move**" , various buttons for rotation (   ) , and for zooming (   ) the views. With  can be determined, whether the objects are to be seen solidly or as wire frame. Especially the following is to be mentioned: The buttons       determine whether the coordinate systems, the ground, bodies, isolators, points, and excitations as well as measures and labels should be selectable or not. In order to ensure that e.g. only isolators can be selected, one can define all other objects as "not selectable". The button  switches the visualization of the coordinate systems for main stiffness and main inertias on or off.

The button  switches off or on the calculation of the static displacement. This feature is useful for systems with automatic leveling (airsprings), where the static displacements are compensated automatically.

With one click with the right mouse button on the Toolbar you can show or hide groups of functions.

4.4.6 **Status Bar**

In the status bar at the lower edge of the program window different coordinates are displayed:

- the current cursor position (only in the 2D-views, the third (undefined) coordinate is not displayed),
- the local coordinates of the selected object. If a group of objects is selected, the local coordinates of the last selected object appear (cf. section 4.5.2).
- the relative values (dx, dy, and dz as well as the angle dphi) when dragging and rotating with respect to the local coordinates. This is helpful for positioning objects.

The ball on the right page displays whether the calculation results are current (green) or not (red). If one moves the cursor along the individual menus, in the status bar additionally provides information on the respective menu option. If several objects are selected, their number is displayed too.

4.5 The construction of models

4.5.1 Creation of objects

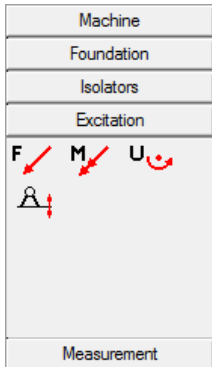

In order to create an object, click on one of the group buttons in the object bar. Buttons for the available objects appear (for instance machine: block, prism, cylinder, sphere, point, CAD Import, and free prism). Pressing one of the buttons puts **ISOMAG** into the insert mode (the cursor gets a "+" sign). A click into one of the 2D-views creates the object. It receives the coordinates of the current mouse position (cf. section 4.4.6) with consideration of the current grid adjustment ("Extras/Settings...").

fig. 4.8 Object bar

The unknown third coordinate is set zero. If the button  is locked, the parameter dialog of the new object opens automatically (cf. section 4.5.3).

With the first foundation structure a foundation is created automatically. Additionally - if the user requires - all springs between machine and environment from now on act between machine and foundation (query: "There are Isolators between machine and environment. Should they work between Machine and Foundation from now?"). In order to create a spring between foundation and environment, the foundation must be selected first.

Object names identify the individual model objects. They are shown in the four views as labels. One switches a label on or off over the menu option "Edit/Label" or via context menu. If several objects are selected, **ISOMAG** applies the instruction to all these (cf. section 4.5.4.4).

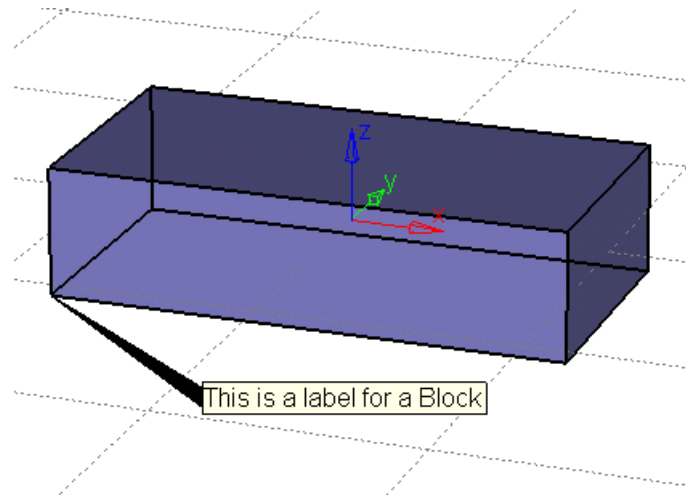



fig. 4.9 Example for a label

For creating a measure initial and end point must be determined. For this you click on the corresponding body edge. The program selects the point on the edge, which is closest to the mouse position. The process can be aborted by ESC. How the arrangement of the line and the value of the measure can be changed, is described in the section 4.5.4.2.

4.5.2 Selecting objects

For editing, copying, or deleting of objects they must be selected. You can select only one or a group of objects. The latter has the benefit that for example several isolators can be changed comfortably at the same time or results of different objects can be put to one result window. All selected objects appear as wireframes in the foreground. The color of the outline is determined in the dialog "Extras/ Settings...". The last selected object is shown in red and its reference coordinate system is displayed. The position coordinates of this object as well as the quantity of selected objects can be seen in the status bar.

4.5.2.1 Selecting objects in one of the model views

Objects can be selected one by one by a click on them with left mouse button. If a object is displayed as a wireframe ( in the toolbar), a body edge must be hit. If one object lies behind another, the front object is selected. If you want to select several objects, you must keep the shift key pressed during clicking. If one clicks with shift key pressed on an already selected object, it is deselected. For the deselection of all objects you have to click on a free area.

Several objects can be selected also by dragging a rectangle. All objects become selected, which are situated totally or partly within the rectangle. The front object is shown red. In the model views only visible objects can be selected.

4.5.2.2 Selecting objects in the tree view

The selection is done similar to the one in the Windows Explorer. One activates an individual object by one click with the left mouse button. With pressed Ctrl key further objects can be selected/deselected, with the shift key. Only the visible (folded up) objects are considered.

4.5.3 Properties of objects

Objects have dialogs with several property pages. One opens these by means of:

- a doubleclick on the object in the model or tree view,
- the Context menu ("Properties..."),
- the menu bar ("Edit/Properties") or
- the enter key (select object before).

For all parameters both the input of simple numbers as well as of mathematical functions (e.g. $\sin(\pi/2)$ or $3+4$) is possible (cf. section 7.1). Note that then the physical unit changes automatically into the respective SI unit.

By "Apply" the program transmits the data from the dialog to the objects. The display is updated, i.e., the modifications are visible in the project. "Cancel" aborts this action and re-creates the status before opening the dialog.

The following points describe the dialog pages "General", "Position", and "Dimensions", which are almost identical for all objects. The remaining parameters are described in the corresponding part in section 4.5. Also several objects can be changed at one time (cf. section 4.5.3.4).

4.5.3.1 General properties

Here a name can be assigned to the object and the color can be selected. The name can be displayed on a label (fig. 4.9).

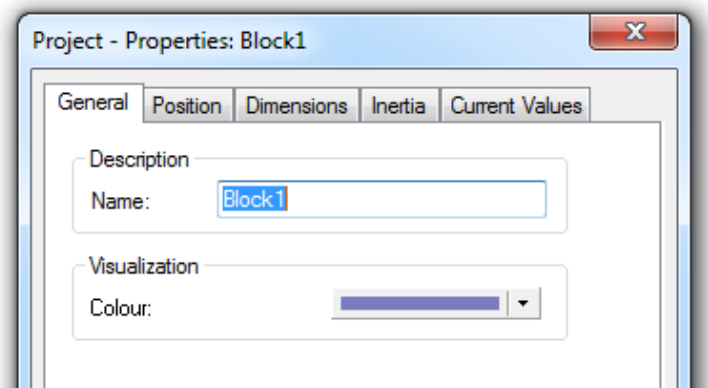

fig. 4.10 General parameter dialog

4.5.3.2 Position

If this dialog page is opened, the values first display the actual position of the reference point of the object - **relative to the parent object**.

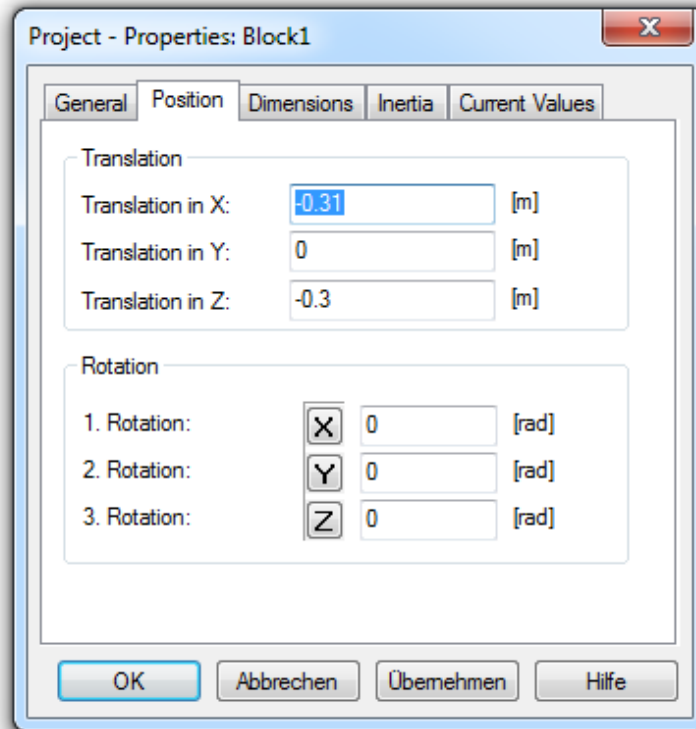

fig. 4.11 Dialog for the position of a body

One can determine both a translation in x-, y- and/or z-direction and a rotation around the x-, y- and/or z-axis. The object is rotated successively around the indicated axes. It has to be noted that with a rotation around x the position of the other axes changes. A following rotation around e.g. z refers then to the rotated position of the z-axis. You can modify the standard order x, y, z: If one moves with the mouse over one of the buttons, the pointer transforms into an arrow, which points up or down - both coordinates exchange their place. **Pay attention to correct signs!**

Exceptions: In the parameter dialog of the ground excitation only rotation values, with machine and foundation only translation can be specified.

4.5.3.3 Dimensions

The inputs on this dialog page are object dependent. For example three lengths are to be given as parameters for a cuboid. For a sphere the diameter has to be put in. **Exceptions:** For **isolators** it must be first determined whether they have a cuboid or a cylindrical shape (cf. section 4.6.4). For the different kinds of **the excitation** one can vary the arrow length. For the **ground** one has to specify the length in x and y-direction, the thickness, and the tile length (cf. section 4.6.5). The tiles are always

square; the input of the size serves only for visualization. It is not exploited in the calculation.

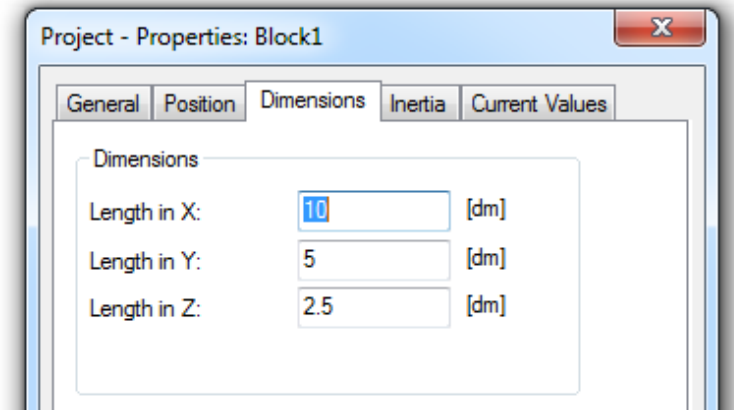

fig. 4.12 Dialog for the dimensions of a body

4.5.3.4 Synchronous parameter input of multiple objects

A synchronous parameter input of multiple objects is possible too: if only **bodies** (block, prism, cylinder and sphere) (cf. section 4.5.2) are selected the values for translation and rotation can be given in the dialog page "Dimensions". They then apply to all bodies. Thus bodies can e.g. be aligned in one coordinate direction.

If you have selected only **isolators**, the complete parameter dialog opens. Thus if a foundation is to be equipped with four isolators of the same type, it requires only once input of all values.

If different **objects** are selected, the dialog refers to the object selected last (shown in red).

Table 4.4 The table shows the behavior of the control elements during a synchronous parameter input for multiple objects

Control	Contents are equal	Contents are different
Input field	Length in Z: <input type="text" value="100"/> [mm]	Length in Z: <input type="text"/> [mm]
List box	Approach: <input type="text" value="Without Damping"/> ▾	Approach: <input type="text"/> ▾
Check box	<input checked="" type="checkbox"/> Curve or <input type="checkbox"/> Curve	<input checked="" type="checkbox"/> Curve

If the user does not change control elements which represent different contents, the control elements retain their respective contents.

4.5.4 Manipulation of objects

4.5.4.1 Moving objects

All objects can be placed arbitrary in the model views (with respect to the selected grid adjustment -"Extras/Settings..."). For moving objects you proceed as follows:

- Switch to the "Select and move" mode by pressing ,
- Select object(s) (cf. section 4.5.2) and drag them into the new position with the left mouse button pressed,
- Release mouse button.
- Alternatively: Moving selected objects track with the arrow keys. For this the mouse pointer must be located in the 2D-view, to which the input refers.

The current position (in local coordinates) and the relative translation of the last selected object as well as the position of the cursor are displayed in the status line. The movement can be aborted by pressing ESC or the right mouse button.

The possibilities given with the measurement comfortably support the exact positioning of objects (cf. section 4.5.4.2).

4.5.4.2 Rotation

For a rotation you proceed as follows:

- Switch to the "Select and rotate" mode by ,
- Select the object(s) (cf. section 4.4.2) and turn them into the new position with the left mouse button pressed into the new position,
- Release mouse button.

Thereby the rotation takes place around the respective reference coordinate system of the objects.

The current angel (in local coordinates) and the relative rotation of the last selected object are displayed in the status line. The rotation can be aborted by pressing ESC or the right mouse button. After the rotation the rotation angles in the parameter dialog again receive their default order x-y-z.

4.5.4.3 Changing measures

If the position of dimension lines and/or measurements are to be manipulated, one drags them with pressed left mouse button to the desired position. The automatic arrangement can be restored in the parameter dialog of the respective measure. The general dialog "Measurement" (tree view) determines the color of the dimension lines, the distance between body edge and measure, the arrow length, and the letter

size. These adjustments apply to all measures. If one changes the dimensions or the position of an object, the corresponding measures are adapted automatically. One can use this, in order to exactly position objects.

4.5.4.4 Label

Labels showing the object names can be switched on and off in the menu "Edit/Label". With pressed mouse button the text can be placed arbitrarily. Thereby its position changes in all four views. Also the fixation point of the label can be manipulated: One click on the tying triangle and selects - with pressed mouse button - one of the alternative points shown in red. When moving the mouse the label docks to the point, which is next to the mouse pointer. Again the modification affects all views.

The tree view (section **4.4.3**) is composed of the individual object names. In the printing log they serve as the heading for the individual objects. The names are generated automatically by the program. Nevertheless they can be modified at any time as follows:

1. Click on an already selected object in the tree view. This allows to type in a new name. Terminate the input with "Enter".
2. Modify the name on the first page of the parameter dialog.

If an object name was modified, all parts of the program are affected (structure, tree, printing log, etc.).

4.5.5 **Deleting objects**

Selected model objects are deleted without a further confirmation by pressing the "Del" key or via context menu. The action cannot be reversed. The project, the principal stiffnesses and principal moments of inertia, the ground, and the machine cannot be deleted.

4.5.6 **Copy, cut, paste and duplicate objects**

Selected objects (cf. section **4.5.2**) can be copied via the Clipboard and thus be exchanged between different projects. The following keys activate these functions:



- "Ctrl+X " cuts the selected objects from the structure and copies them into the Clipboard,
- "Ctrl+C " copies the selected objects into the Clipboard,
- "Ctrl+V " inserts **the ISOMAG objects** from the Clipboard into the structure.

The actions can be performed via the menu "Edit" and as some of them via context menu too.

If the foundation is selected when inserting objects, these are assigned to the foundation. Thereby the possibility exists of assigning objects, which are assigned falsely to the machine, to the foundation.

Selected objects can be also duplicated. Thereto you open a dialog via "Ctrl+D" or the menu "Edit/Duplicate...". There the number of copies as well as their translation in x -, y and z-direction can be input. The new objects receive automatically a unique designation, which consists of the term of the respective original - extended by a number.

4.5.7 Undo and redo of manipulations

The undo/redo functions allow reverting and repeating of the above functions. The functions are available via the buttons  and . Undo puts the model into the state before the last action. The undone action can be restored by the redo function. Via the small arrows the undo/redo menu is opened. Here all recorded actions are listed. A continuous set of actions can be undone and restored at once.

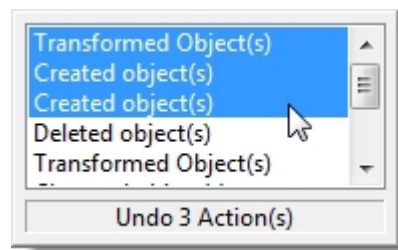

fig. 4.13 Menu for Undo/Redo

The recorded actions may contain one or more changes regarding one or more objects. For example all changes in the properties dialog of an object are combined to one undoable action as soon as the dialog is closed. Please note: the number of recorded actions is limited by 20.

4.6 Object description

4.6.1 Machine and foundation

Machine and foundation are the parent objects of the appropriate bodies, isolators and excitations (see **fig. 4.3**). If one changes the position of machine and foundation, all child objects are moved accordingly. Machine and foundation can thus be used, to change the position of all child objects with respect to each other. Moreover it is possible to parameterize the inertia properties.

4.6.2 Body

ISOMAG gives various possibilities for the description of the inertia parameters of the system to be isolated.

If the inertia properties of the system are unknown, they have to be determined by the program. The program operates with geometrical fundamental bodies (block, prism, hollow cylinder, and sphere), for which the inertia properties (mass, principal moments of inertia, position of the center of gravity, and axes of principal inertia) are

known. In the program one describes these basic or partial bodies and assembles them together to the final structure (cf. section 4.5.1).

Parameter dialog for the description of the inertia

The dialog page "Inertia" in the parameter dialog allows defining the inertia properties. Different options are available (cf. fig. 4.14).

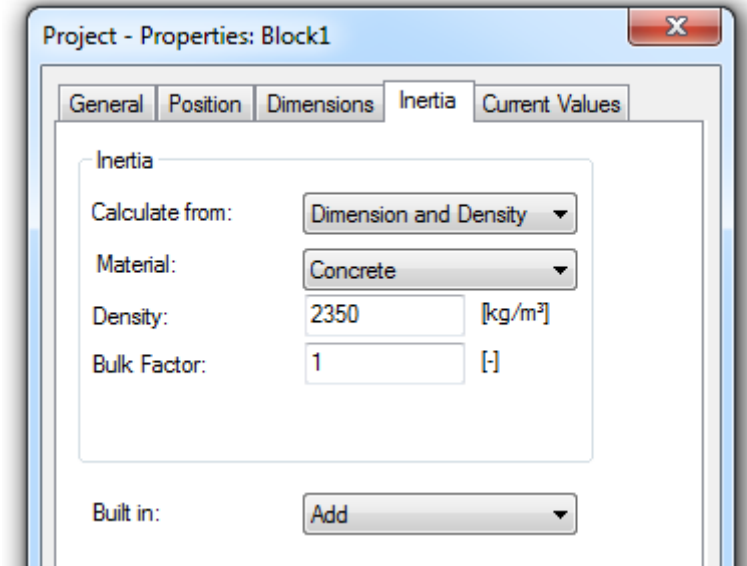

fig. 4.14 Parameter dialog for the description of the Inertia of bodies

If the is determined inertia from "**Dimensions and Density**", one assumes that the mass is uniformly distributed over the body. Via the bulk factor heterogeneities in the mass distribution can be considered. **Table 7.1** describes the used relations. The density can be either entered directly or taken from the database. For this the desired material is selected in the combobox. If the list does not contain the required material, it can be added to the database.

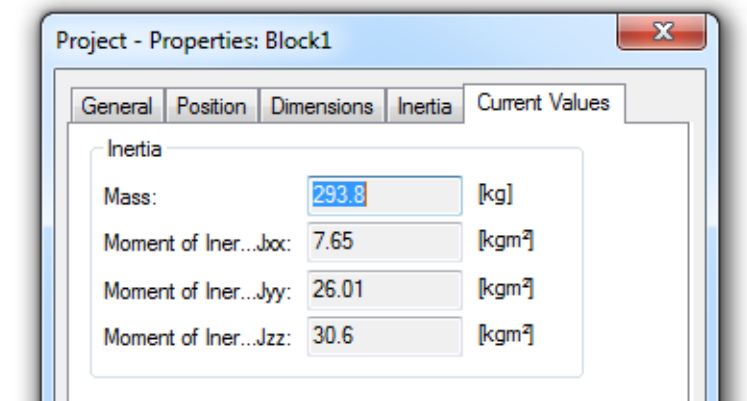

fig. 4.15 The current inertia values of Block1

By default the inertia of a partial body is added to the inertia of already existing bodies (option "**Built in: Add**"). However to consider for example drilled holes or recesses, the inertia of partial bodies can be also subtracted.

The calculated values for the mass and the moments of inertia of the partial body are shown on the last dialog page (fig. 4.15). Only J_{xx} , J_{yy} and J_{zz} are displayed. If the products of inertia are not equal to zero (like J_{xy} of the prism) these are considered exactly by the program, but not displayed.

4.6.3 Advanced bodies

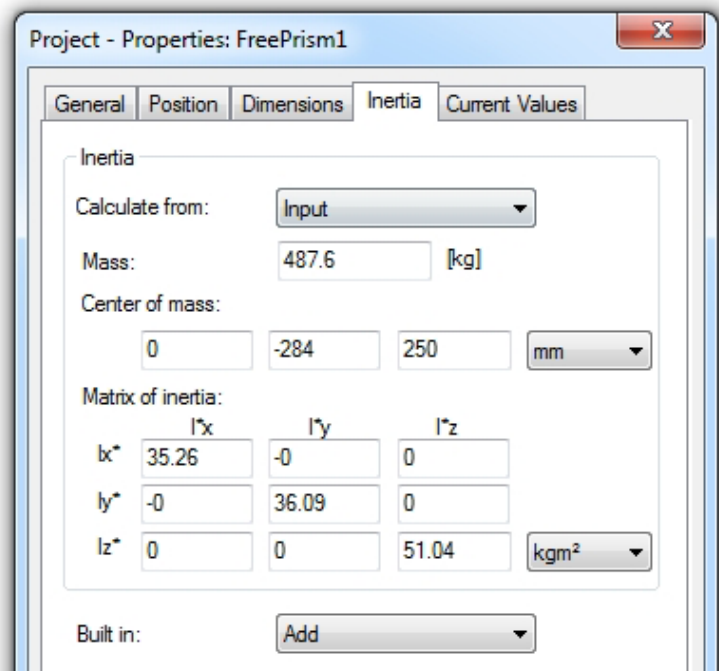

fig. 4.16 Complete inertia parameters

Beside of the simple bodies from above, more complex geometries can be used in **ISOMAG** too. For such bodies it is in general not sufficient to describe the inertia parameters by the main diagonal elements of the inertia matrix. Thus, on the page inertia all elements of the matrix can be changed (see fig. 4.16).

Since the inertia parameters of the single bodies directly influence the inertias of the compound elements (machine, foundation), their complete inertia data are available too.

4.6.3.1 Free Prism

The free prism is an extension of the prism, where the cross section can be defined.

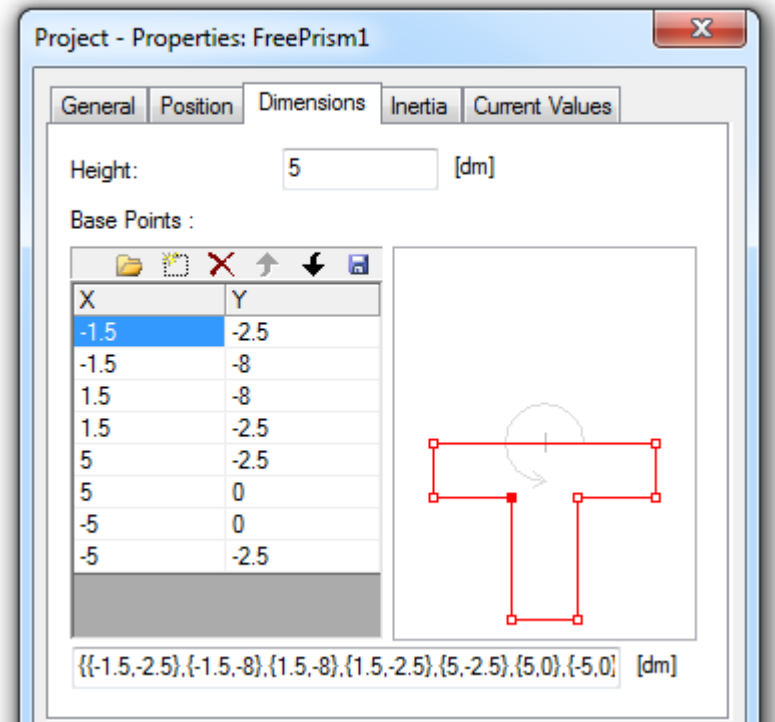

fig. 4.17 Definition of the cross section of a free prism

As shown on fig. 16 the cross section is defined via a vector of 2D-points. The prism is then extruded in by its height in z-direction. The points of the cross section are connected in ascending order and the last is connected with the first point. The points can be defined in the list view or in vector syntax in the lower area. The 2D-view on the right displays the current cross section. The points can be tracked here interactively.

Please note: the points have to be defined in anti-clockwise direction. This is important for the computation of the inertia parameters and for correct visualization. If this request is violated, a warning is shown.

4.6.3.2 CAD Import

Using the CAD import arbitrary geometries can be imported within ISOMAG from STL-files. STL is a low level CAD format. The boundary of the body is represented by a net of triangles. All CAD tools which are usual in the market are able to generate STL-files. Volume and inertias are computed automatically from the geometry during the import process but can be changed manually.

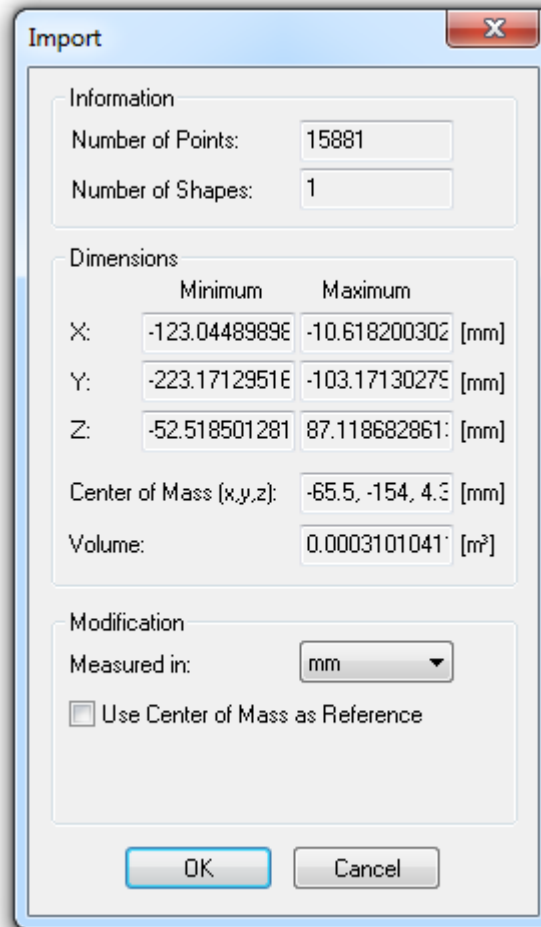

fig. 4.18 Information about an imported CAD-file

On the first page of the property dialog of the CAD import element the import is started by selecting a STL-file. STL-files in binary as well as text format are supported. After reading the file the following dialog, which shows some information about the imported data appears.

The dialog shows how many points and shapes are contained. Via minimum/ maximum and center of mass it is shown how the points are distributed. In the lower area of the dialog the points can be modified:

Measured in: allows the definition of the physical unit of the imported coordinates, which is not defined for STL-files. By default the ISOMAG unit for dimensions is used. By changing the unit in this dialog the dimensions of the imported body are changed as shown by its minimum/ maximum values.

Use Center of Mass as Reference: The center of mass of imported bodies normally does normally not coincide with the reference coordinate system. Activate this option to transform the points in a way that the center of mass becomes the reference coordinate system. This function is helpful when the points are located far away from the reference coordinate system. You should not use this function if several CAD files

are to be imported. In this case the positioning of the STL-bodies to each other is lost.

During the import please take care on the correct dimension and position of the geometries. Due to imported bodies with very small or large dimensions or a large distance to its reference coordinate system, the 3D-views might not be able to adapt itself in the right manner. Empty 3D-views or unexpected visualization are a sign for non-correct dimensions of imported CAD data. In this case the import should be repeated with correct settings. Or the STL-files should be regenerated using a reference coordinate system closer to the points.

Large CAD-objects influence the performance and memory consumption of **ISOMAG**. Most CAD tools allow the reduction of complexity for STL export. Use this functionality if ISOMAG becomes significantly slow, needs a huge amount of memory, or generates large files.

4.6.4 Isolators

With these objects both isolators and general spring damper elements (auxiliary springs or pipelines) can be modeled. Their creation was described already in detail in section 4.5.1. Usually they are of the same type, i.e. they possess identical parameters. In this case it is advisable to deactivate the option "**Parameter Dialog during Creation**": All isolators can be placed on the worksheet first and be parameterized afterwards as a group in one go (cf. section 4.5.3.4).

There are three types of isolators, which are represented by different colors:

- Isolators, which are situated between machine and environment (blue-brown).
- Isolators, which are situated between machine and foundation (blue-grey),
- Isolators, which are situated between foundation and environment (grey-brown).

If one modifies these allocations - which are only practical and possible, if the project possesses a foundation - the colors of the isolators change accordingly. At the same time the position in the object hierarchy may change **fig. 4.3**.

4.6.4.1 Arrangement

Normally machine and foundation should be placed horizontally. In order to achieve this, move and/or turn the isolators until the axis of a principal translatory stiffness (green arrow) coincides with the z-axis of the center of gravity coordinate system (blue arrow). Alternatively in particular if additional static loads are to be considered – one can display the static displacements (Menu "Results") and manipulate the position of the isolators, until the tilts become zero. It is advisable to align the machine first. For this one regards the machine center of gravity as well as the elastic center of the isolators, on which the machine is mounted (spring center of machine). For the alignment the isolators of the machine are manipulated. In order to align machine and foundation, one regards their total center of gravity as well as the elastic center of the foundation mounting springs (spring center of the foundation). For adjustment the springs at the foundation are manipulated.

Isolators have a reference point (cf. section 3.1.1.7). This point represents also the junction point of the spring element with the rigid body (machine or foundation; cf. Object hierarchy (fig. 4.3). The side opposite of the reference point is type-dependent connectedly with the foundation or the rigid or flexible ground.

4.6.4.2 General parameter dialog

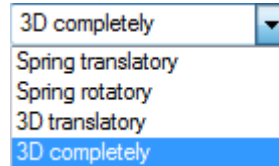

fig. 4.19 Listbox for the selection of the isolator type

Here one can select between "Spring translatory", "Spring rotatory", "3D translatory" and "3D completely". Thus one determines, in which coordinate directions (with respect to the element coordinate system) the element acts. For these coordinate directions the values for stiffness and damping as well as limiting values can be specified (section 4.6.4.3 to 4.6.4.5). With the button "Select from Database..." isolators can be selected from the database. Details are shown in section 5.1.

If one selects an isolator from the database, the type, article number and manufacturer are shown on the dialog page "General". All parameters are transferred to the isolator and updated in the corresponding dialog pages. If one overwrites one of these values, the database link is deleted.

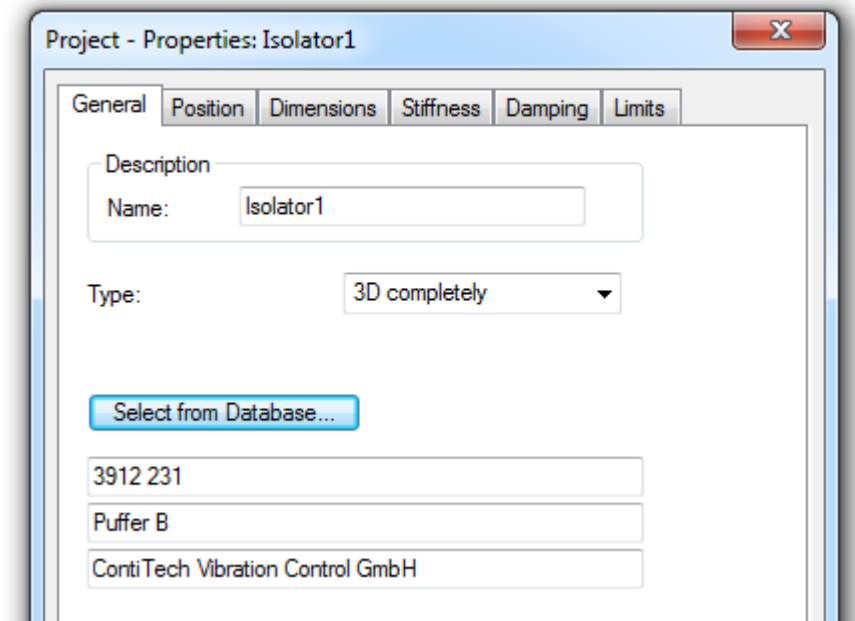

fig. 4.20 Example of an isolator selected from the database

4.6.4.3 Parameter dialog "Stiffness"

It depends on the selected isolator, which parameters have to be given in this dialog (**fig. 4.19**). If one uses e.g. a translatory spring, only one value for the stiffness in z-direction has to be put in. If one selects "3D completely" instead, then all parameters shown in **fig. 4.21** are to specify. If one activates the option "Curve" and clicks on "Edit...", the characteristic curve dialog opens. It is described in detail in the section **5.2**.

With the "Factor c_{dyn}/c_{stat}" the "inertness" of highly elastic materials can be considered approximately. Due to the creep behavior of these materials they indicate a seemingly higher stiffness under oscillation stresses or high velocity stresses compared to the static case, for which the values are usually estimated and given. For the dynamic calculation in **ISOMAG** the input stiffness is multiplied by this factor (cf. **section 3.1.4.6**). Manufacturers indicate it as 1 to 1.5 for rubber items. For steel springs it equals 1.

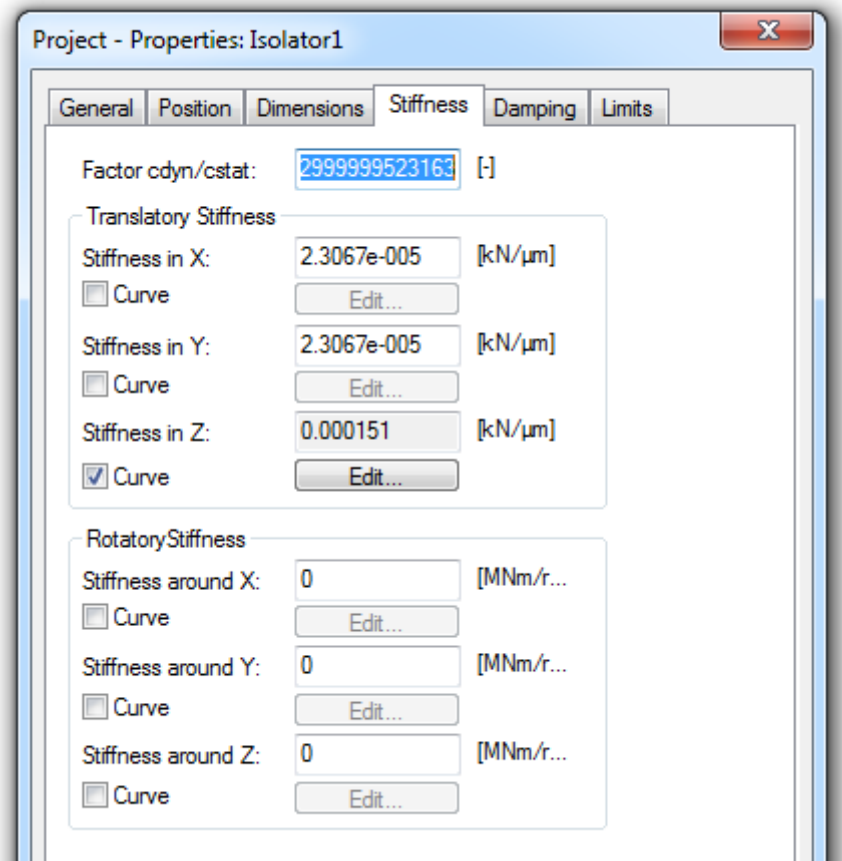

fig. 4.21 Parameter dialog for the stiffness of isolators

4.6.4.4 Parameter dialog for the description of the damping

In the program weak damping ($D < 0.15$) can be considered. It is sufficient for the material damping of the isolators. **fig. 4.22** shows the dialog for the input of the damping. It can be selected whether one works with or without damping. With the "Approach for steel" **ISOMAG** uses a LEHR damping measure of $D = 0.005$. With

"Approach for rubber" $D = 0.05$. This damping acts in all coordinate directions, which the isolators possess according to its type (**fig. 4.19**): e.g. for: "3D complete" e.g. in all six directions. If "Input" is selected, a value can be entered for each coordinate direction.

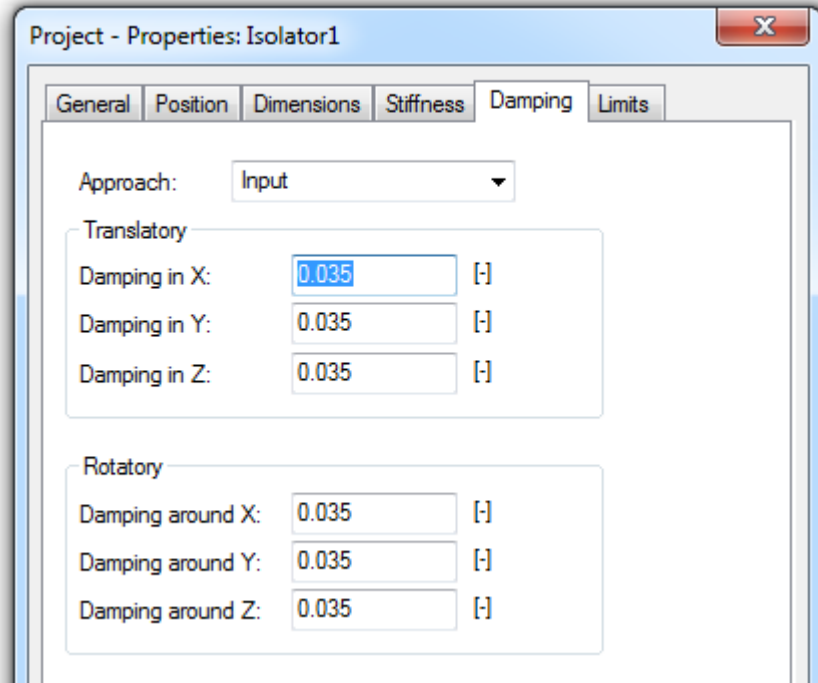

fig. 4.22 Parameter dialog for damping for the example of the isolator type "3D complete"

4.6.4.5 Parameter dialog for limit values

Many manufacturers indicate limiting values for the static loads of their isolators. These values can be given in the dialog page shown in **fig. 4.23**. It depends again on the selected isolator type which edit boxes are shown for the input (**fig. 4.19**). Admissible values for both, forces and displacements, can be entered. Positive values describe pressure loads, negative values tension forces. The maximum values should be larger than the minimum values. If both, maximum and minimum are equal to zero, the program assumes that no limiting values exists.

If one of the limits is exceeded, a corresponding message appears at the end of the calculation.

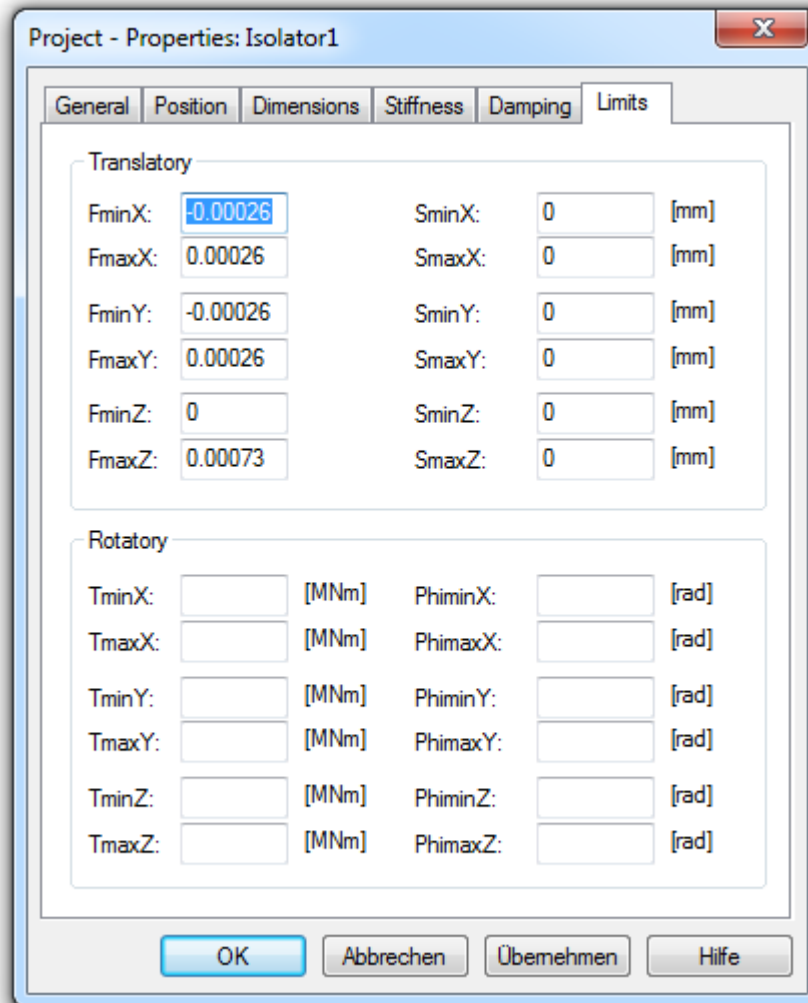
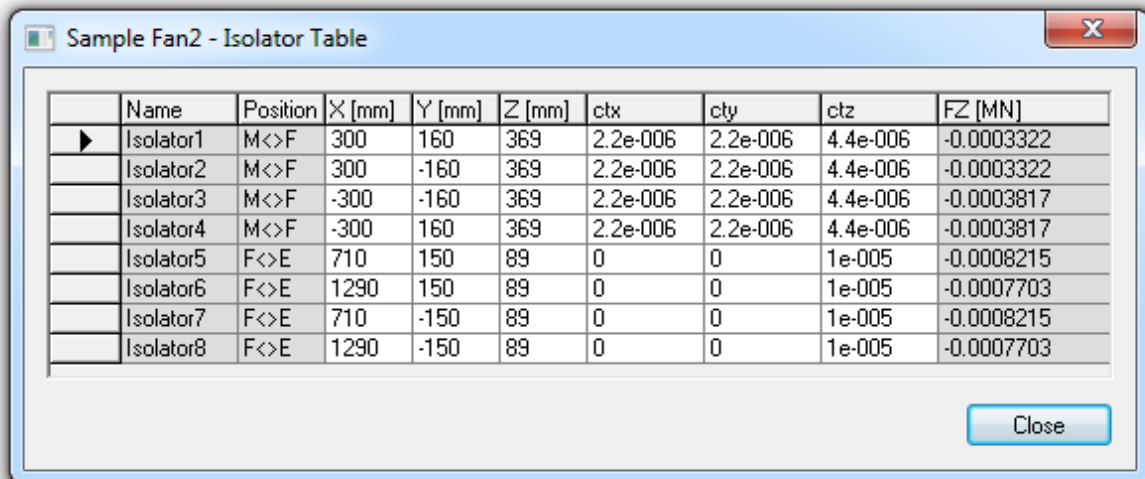

fig. 4.23 Dialog for limiting values for the example of the isolator type "3D complete"

4.6.5 Isolator table

Using the menu "Edit/Isolator Table..." a table is opened which shows a list of all isolators of the model. The isolators are sorted according to their position, that is whether they are located between machine and ground, foundation and ground or machine and foundation. Position and stiffness (if not defined via a look up table) can be changed here. Each manipulation leads to a recomputation of the results.

When the isolator table is shown, all other **ISOMAG** functions are disabled. The 3D-views and result windows will be updated anyway in order to visualize the changes. In order to check the effects of the changes on certain results (for example the main stiffnesses) these windows are to be opened in advance.



	Name	Position	X [mm]	Y [mm]	Z [mm]	ctx	cty	ctz	FZ [MN]
▶	Isolator1	M<>F	300	160	369	2.2e-006	2.2e-006	4.4e-006	-0.0003322
	Isolator2	M<>F	300	-160	369	2.2e-006	2.2e-006	4.4e-006	-0.0003322
	Isolator3	M<>F	-300	-160	369	2.2e-006	2.2e-006	4.4e-006	-0.0003817
	Isolator4	M<>F	-300	160	369	2.2e-006	2.2e-006	4.4e-006	-0.0003817
	Isolator5	F<>E	710	150	89	0	0	1e-005	-0.0008215
	Isolator6	F<>E	1290	150	89	0	0	1e-005	-0.0007703
	Isolator7	F<>E	710	-150	89	0	0	1e-005	-0.0008215
	Isolator8	F<>E	1290	-150	89	0	0	1e-005	-0.0007703

fig. 4.24 Table with position and stiffnesses of the isolators

By a right click on the column headings of the table the stiffnesses and the translator loads and displacements can be switch on and off.

4.6.6 Environment

The environment - in the example **fig. 4.25** it is called the base plate - in most cases represents the floor, on which the machine, foundation, etc. are placed. There are three models "Rigid", "Beam", and "Plate".

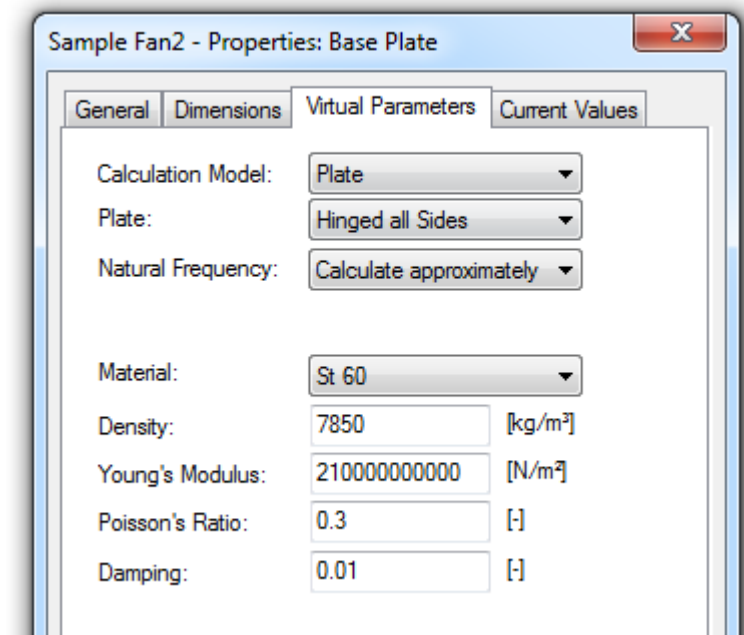

Sample Fan2 - Properties: Base Plate

General Dimensions Virtual Parameters Current Values

Calculation Model: Plate

Plate: Hinged all Sides

Natural Frequency: Calculate approximately

Material: St 60

Density: 7850 [kg/m³]

Young's Modulus: 210000000000 [N/m²]

Poisson's Ratio: 0.3 [-]





Damping: 0.01 [-]

fig. 4.25 Dialog for the description of the environment

In the calculation the thickness of the environment (dialog page "Dimensions") is used only, if the mounting is flexible, the calculation model "Plate" or "Beam" was selected, or if the natural frequency is estimated approximately.

Using the selected approach **ISOMAG** calculates the virtual mass and the virtual inertia from the parameters (cf. section 2.6). These results are displayed on the dialog page "Current values".

4.6.7 Excitation

The buttons , , , and  on the Object bar represent the different kinds of the excitation. **ISOMAG** supports force-, torque-, imbalance, and ground excitation. They can be constant, periodic or of impulse-type. The reference point of the forces and torques is their application point. In the model it is symbolized by the head of the arrow.

For ground excitation it can be defined whether it is a displacement, velocity or acceleration. The setting is made on the first page of the parameter dialog of the ground excitation. The physical quantity of the parameters on the dialog page "Excitation" is selected accordingly. If velocity or acceleration setting has been selected, the excitation is converted into a displacement by means of single or double integration in the frequency range. Please consider this when an acceleration is entered. Oftentimes acceleration curves are given which lead to a remaining velocity after the indented end of the excitation. This leads to unexpected results. For that reason you should check the resulting velocity and displacement signals. They can be displayed in result windows using the context menu of the ground excitation element.

Parameter dialog for the description of the excitation

fig. 4.26 shows the parameter dialog for the force-, torque- and ground excitation.

For force-, torque- and ground excitation harmonic, impulse shaped and user defined signals can be defined.

Harmonic: For the harmonic excitation you can enter "Absolute value and phase" or alternatively the coefficients of the cosine and sine components. Both input modes describe the same fact and can be converted into each other. Similarly, one can either specify the orders of the harmonics and the fundamental frequency, or the frequency for each harmonic.

Impulse: As impulse shape rectangular, triangular and half sine can be selected. pulse shapes, there is the half sine pulse. Single pulses, periodic pulses and arbitrary pulse sequences are possible. If several pulses with decaying amplitude are to be generated sequentially, several excitation objects can be set to the same position and parameterized accordingly. Another option is to use a user-defined excitation as is described in the following paragraph.

With proper parameterization, a sinusoidal excitation can also be modeled with the half sine pulse. However, harmonic excitation should be preferred to pulse excitation

then. The pulses are transferred to the frequency range for calculation with FFT. Harmonic excitations are defined in the frequency range already. Transformation is not required here. The accuracy of the calculation increases and the required calculation time drops.

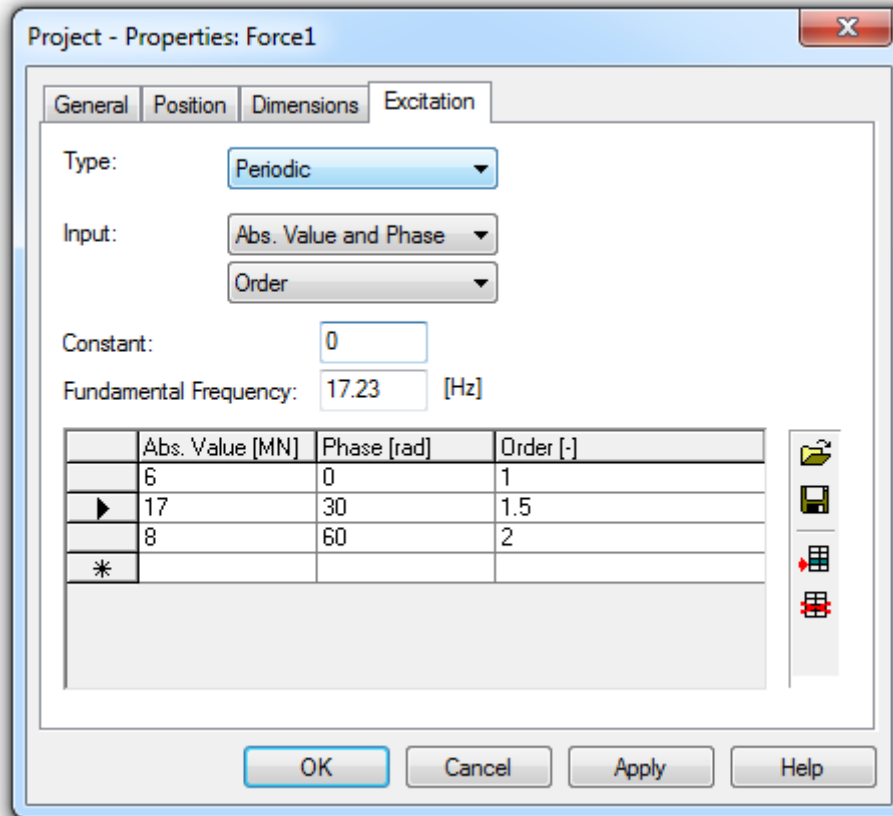

fig. 4.26 Dialog for the description of the excitation

User defined: By means of user-defined excitations any curve shapes can be modeled as excitation. Select "User-defined" as type. Go to "Edit..." to open the dialog for the editing of the characteristic curves. There you can input values manually, change them graphic-interactively or import them from files. Note, however, that the input curves are continued periodically since the calculation process assumes periodicity of the excitations. Therefore, entire periods or short pulses (see section 4.2.1.3) should be described.

During the calculation the curve is transferred into the frequency range with FFT. In the process it is sampled with the calculation step size. If the curve changes too much within the calculation step size, it cannot be represented correctly. Hence, the step size of the data should be larger than the calculation step size. In such a case, a warning will be given during the calculation. This warning can be ignored if the curve within the calculation step size changes only slowly.

4.6.7.1 Excitation caused by Earthquakes

Excitations caused by earthquakes are ground excitations. The highest components with regard to their amounts are directed in the horizontal (x or y) direction. For vertical acceleration it is recommended in [30] to calculate with 2/3 of the horizontal acceleration. The excitation is mostly available as measured acceleration curve. Such data are provided, for instance, by the German Society of Earthquake Engineering and Structural Dynamics or via the European Strong Motion Database (<http://www.isesd.hi.is>).

To model an earthquake excitation in ISOMAG, ground excitation is to be used. Set it to acceleration. To obtain the 2/3 splitting between horizontal and vertical acceleration, specify an angle of -33.7 ° as rotation around y-axis. Select “User-defined” under “Type” on the dialog page “Excitation”. Go to “Edit...” to open the characteristic curve dialog. There you can import your data from an existing file via “Open file”. A wizard will take you through this process.

Since for excitation the absolute value is input, but the acceleration curves are available in the horizontal direction, the absolute value must be multiplied by the factor

$$\cos\left(\arctan\left(\frac{2}{3}\right)\right) = 1.2 \quad (4.2)$$

You can do this with the available raw data either prior to the import, for instance, in Microsoft Excel or after the import in the characteristic curve dialog.

Note the explanations about pulse excitations in the calculation given in section 4.2.1.3. Make sure that your system gets enough time for “settling” at the “end” of the earthquake. For this purpose, set the end time (see section 4.7.1) of the calculation high enough and extend the excitation curve up to the end time with the amount zero.

4.6.7.2 Imbalance

The parameter dialog for the imbalance excitation is shown in **fig. 4.27**. It allows the input of the amount of imbalance i.e. the input of the product of mass and excentricity ($m \cdot r$), the frequency and the phase shift. Additionally a clockwise (right) or anti-clockwise (left) rotation can be selected.

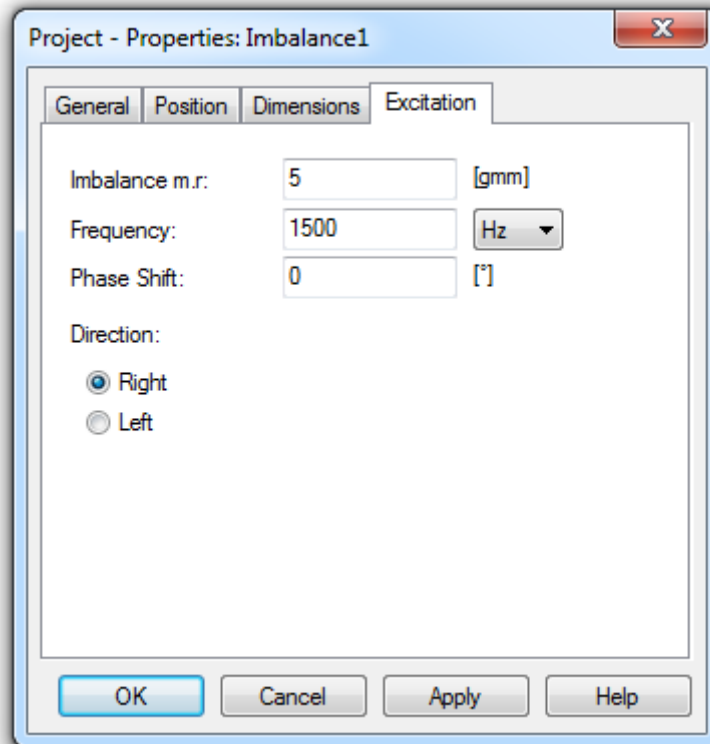



fig. 4.27 Parameter dialog for the description of an imbalance excitation

4.6.8 Points

ISOMAG calculates static and dynamic results for any user-specified point. One can insert as many as desired points into the model. **ISOMAG** calculates static and dynamic results for the points. Thus you obtain the static displacements, motion quantities as function of the time or displacements as functions of the frequency for any point in the model (cf. section 4.8).

4.7 Calculation

By default the calculation of the results is performed after each modification of the model. If the calculation cannot be finished successfully, a corresponding message appears. In this case the title bars of all result windows displays "not up-to-date". The ball in the status line remains red. The displayed results are those of the last successful calculation run.

The automatic calculation can be switched off via  or the menu "Calculation". This is especially recommended if the model is still in creation. In this case a new calculation is executed only if a new result is displayed or the animation is started.

4.7.1 Settings

Using the menu "Calculation/Settings..." the parameters of the computation method can be changed.

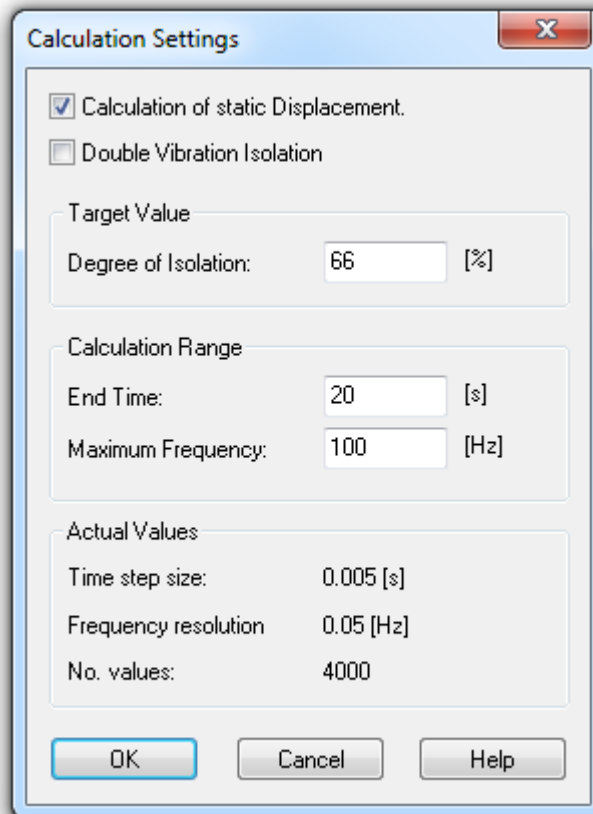



fig. 4.28 Dialog Calculation Settings

With the check box **Calculation of static Displacement** the calculation and animation of the static distortion can be suppressed. This is of interest, for instance, for systems with pneumatic springs and automatic height control. You get the same effect when you use the button  in the toolbar "Mode".

The checkbox **Double Vibration Isolation** can be enabled if a two-mass system is dealt with. The button "Foundation" in the object bar and the wizard for double vibration isolation will be activated then. Once you have created a foundation, the check box cannot be deactivated anymore. When you delete the complete foundation, "Double Vibration Isolation" is deactivated automatically.

The input of the **Degree of Isolation** has no influence on the calculation results. The degree of isolation is displayed in the transmissibility functions merely as an auxiliary line to make evaluation of the results easier (see also section 4.8.2.2 "Display of the achieved degree of isolation").

The parameter **End Time** (T) defines the length of the result signals in the time domain. This value defines the resolution of the points in frequency domain Δf . The following relationship applies:

$$\Delta f = \frac{1}{T} \quad (4.3)$$

Thus, the resolution in the frequency domain can be increased through an increase of the end time.

The parameter **Maximum Frequency** (f_{\max}) is the final value of the frequency responses and transmissibility functions. It also influences the resolution of the signals in time domain. The equation is:

$$\Delta t = \frac{1}{2f_{\max}} \quad (4.4)$$

With this step size, the excitations in the time domain (pulse and user-defined) are sampled. On principle: The smaller the maximum frequency, the wider the step size. Before you define the excitations you should verify whether they will be sampled sufficiently accurately with the selected settings. During the calculation ISOMAG will give a warning if, in the case of user-defined excitations, the step size of the sampling points is smaller than the calculation step size.

If the frequency range is extended beyond 100 Hz, the calculation model of the rigid machine may no longer be valid. This is on condition that the eigenfrequencies in the frequency range are determined only by the elasticity of the isolators. Machine and foundation, in the idealized case, are considered to be rigid. This may no longer be true with higher frequencies. The elasticities of the machine may no longer be neglected then. Impacts from structure-borne noise must be taken into account. ISOMAG will give a warning when the setting dialog is exited.

The current values for time step size, frequency resolution and number of sampling points used for the calculation are given in the lower part of the dialog. Note that the calculation time and required storage space increase with an increasing number of sampling points.

4.7.2 Dimensioning calculation

The dimensioning supports you with the selection of suitable isolators from the database (cf. section 5.1) in order to achieve a certain degree of isolation. The dimensioning calculation takes place within the wizards for **Single** or **Double Vibration Isolation** (Menu "Calculation/Wizards").

4.7.2.1 Wizard for Single Vibration Isolation

The wizard is arranged in such a way, that he is usable without a model too. Data, which is normally extracted from the model (quantity of isolators, minimum excitation frequency, mass), is now given by hand.

Basis for the dimensioning calculation is an oscillator with one degree of freedom. In this way it is assumed that the coordinates of the system are decoupled, which is not fulfilled in general. In this general case the calculation supplies the dimensioning values, which assist the preselection of installation elements.

In certain cases one can apply the formula for the one-mass oscillator to different degrees of freedom and separately design the installation elements for different vibration modes (cf. section 3.1.12.1). In any case, using the natural frequencies, the achieved degree of isolation (cf. **fig. 4.39**), or the forces on the base, one can finally determine how well the selected installation elements isolate the system.

fig. 4.29 Wizard for Single Vibration Isolation

In practice one often designs the one-mass oscillator in z-direction. Therefore the program provides the defaults for this oscillator.

As shown in **fig. 4.29** the desired tuning ratio or the desired degree of isolation must be specified (set the radio button accordingly). If some excitations in the model are already described, the smallest frequency of all excitations is shown in the edit box "Min. Excitation Frequency". The preset mass is equal to the total mass of the sys-

tem. The number of isolators corresponds to the number of the selected items in the model. If nothing is selected, all isolators are included. If necessary the values can be overwritten.

A click on "Next" calculates the required dynamic stiffness and the load of the isolators on the assumption that the weight is distributed symmetrically among them. The used formulas can be found in section **3.1.12.1**.

The results of the dimensioning calculation are now used for the selection of those isolators from the database, whose stiffness in z-direction must be greater than the required stiffness and whose maximum force in z-direction is larger than the maximum load. The search criteria can be modified after actuating "Search>> ". So it is possible to consider for example only isolators from certain manufacturers. Details are given in section **5.1**. The selected type is transferred to the wizard by terminating the database selection with "OK". When terminating the wizard the selection is assigned to the corresponding isolators.

4.7.2.2 Wizard for Double Vibration Isolation

If this wizard is started an intermediate foundation is generated automatically **if it does not exist yet**. Of course you have to select the checkbox "Double Vibration Isolation" of the "Calculation/Settings..." dialog before.

The following actions are executed by **ISOMAG**:

- The isolators between machine and environment act now between machine and foundation.
- A body is created, which fits exactly under the machine.
- Four isolators (or the same quantity as under the machine) of the type selected from the database are created between foundation and environment (ground). They are situated at the corners of the foundation structure or under the machine isolators.
- Alignment of machine and foundation, such that a practical arrangement is obtained.

Note that for the reduction of the degree of isolation the foundation must be as heavy as possible. The foundation mass should be at least five times the machine mass.

The image shows a software configuration window titled "Configuration" with a close button (X) in the top right corner. The window contains four sections, each starting with a blue triangle icon:

- Section 1:** "Please select, how the isolators between foundation and ground should be created!"
 - Three radio button options:
 - Same number like isolators between machine and foundation
 - Four isolators at the comers of the foundation
 - Input number (the model wont be changed!)
 - A text input field labeled "Number of Isolators:" containing the value "4" and a unit indicator "[-]".
- Section 2:** "Input the criterias for vibration isolation!"
 - A text input field labeled "Degree of Isolation:" containing the value "66.6666666666667" and a unit indicator "[%]".
 - A text input field labeled "Min. Excitation Frequency:" containing the value "5" and a unit indicator "[Hz]".
- Section 3:** "For the thickness of the foundation, we suggest one quarter of the maximum of width and length. It is possible to change this value."
 - A text input field labeled "Length in Z:" containing the value "1.7" and a unit indicator "[dm]".
- Section 4:** "Choose the material for the foundation!"
 - A dropdown menu labeled "Material:" with "Concrete" selected.
 - A text input field labeled "Density:" containing the value "2350" and a unit indicator "[kg/m³]".

At the bottom of the window, there are four buttons: "Back", "Next" (highlighted in blue), "Cancel", and "Help".

fig. 4.30 Wizard for Double Vibration Isolation without an existing foundation

If a foundation already exists, another wizard is started:

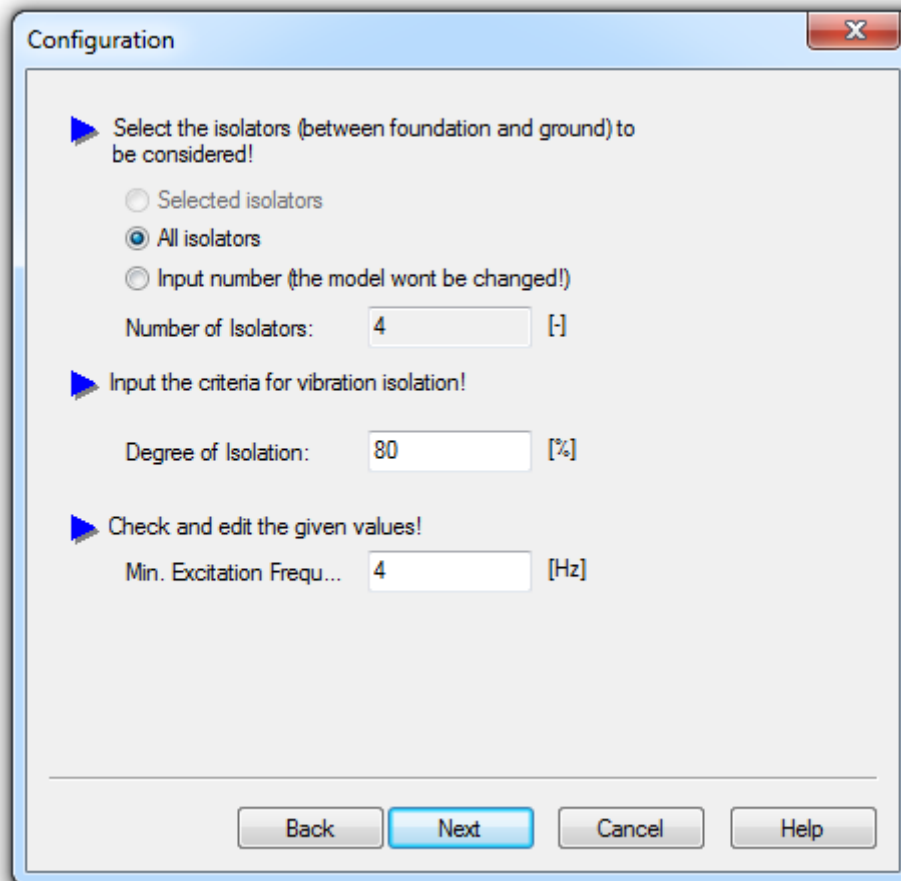

fig. 4.31 Wizard for double vibration isolation with already existing foundation (1)

If the desired degree of isolation cannot be achieved, a note appears in the dialog **fig. 4.32**. Nevertheless a database selection is possible, but the selection criterion "Required Stiffness" is not considered.

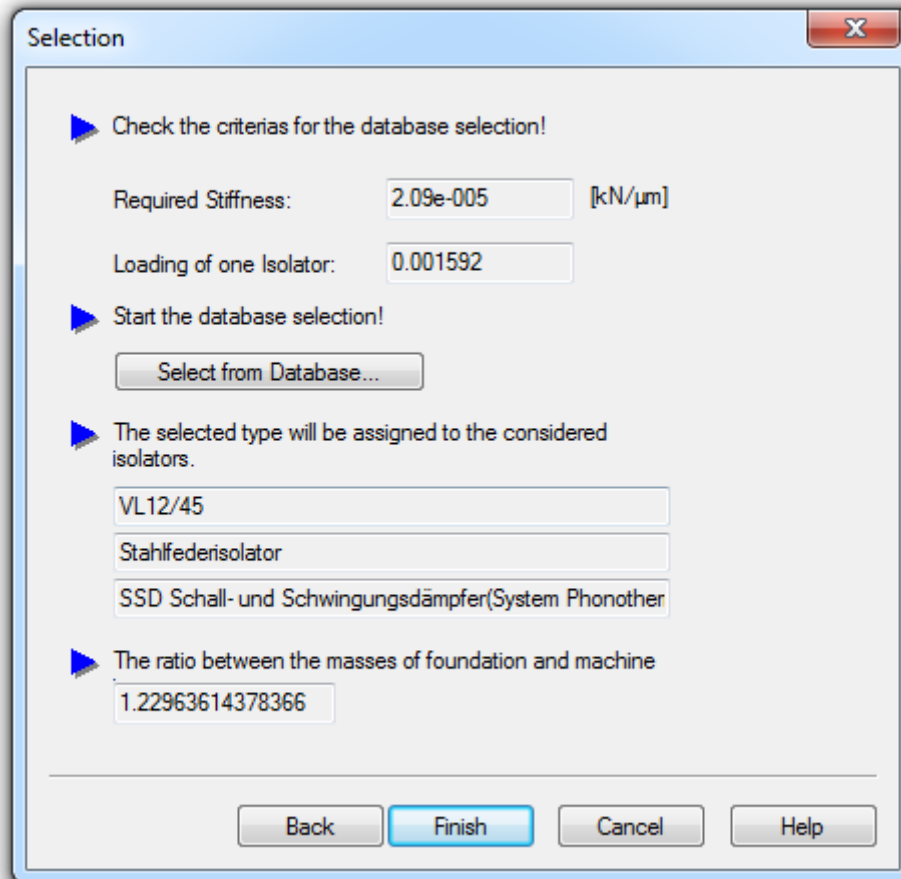

fig. 4.32 Wizard for double vibration isolation with already existing foundation (2)

4.8 Results

ISOMAG supplies static and dynamic results. The static results are shown in dialogs; the dynamic results in result windows (cf. section 5.3). As many as desired result dialogs and windows can be opened. The windows are updated after each successful calculation.

The program supplies the following static results:

- principal moments of inertia,
- principal stiffness,
- static loads of the isolators,
- static displacements (at points, centers of gravity, and isolators),
- Eigenfrequencies and Eigenvalues.

The natural frequencies and vibration modes are calculated. As dynamic results the frequency response, the transmissibility, and the time functions of deflections, veloci-

ties, accelerations at points and isolators, and loads at isolators are available. Additionally the total of the static and dynamic ground loads is determined. The results are displayed via context menus or the menu "Results".

4.8.1 Static results

4.8.1.1 Principal moments of inertia

If at least one body exists on the worksheet, ISOMAG calculates the position of the center of gravity and the principal axes of inertia. They are represented by three blue arrows, each indicating one of the directions of the principal axes of inertia. The arrows meet in the center of gravity. The result dialog (**fig. 4.33**) shows the position of the center of mass, the rotation angles, the directional cosines between CCS and PICS, as well as the total mass and the principal moments of inertia.

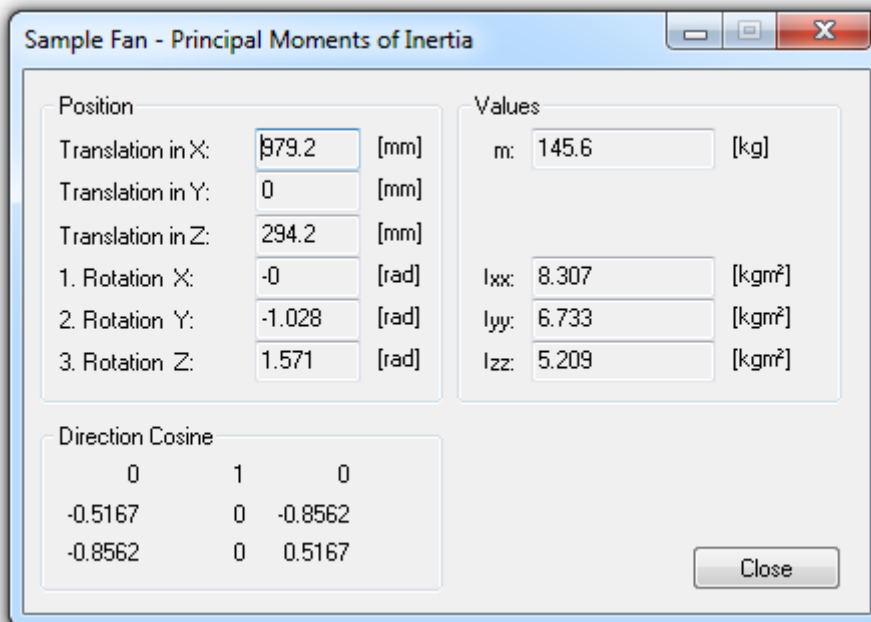

fig. 4.33 Result window for the principal moments of inertia

4.8.1.2 Principal stiffnesses

If one isolator exists, **ISOMAG** calculates the principal translatory stiffnesses. They are calculated for the machine and for the foundation bearing (if existing). Only those stiffnesses, which are larger than zero, are displayed. In the display green arrows indicate one of the principal stiffness directions. If an elastic center exists, the arrows are crossing there. The arrows are updated with each model manipulation. So, for example, in order to align the arrangement horizontally under the influence of its own mass, one can manipulate the isolators until a principal stiffness coincides with the z-axis of the center of gravity coordinate system (the principal stiffness is oriented vertically through the center of gravity).

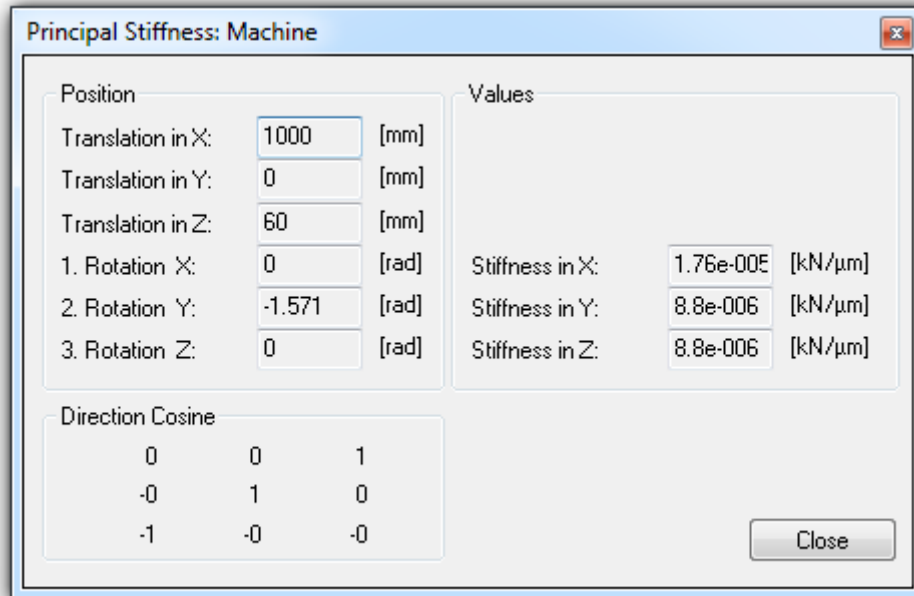

fig. 4.34 Result window for the display of the principal stiffness

The result dialog (**fig. 4.34**) shows the position of the elastic center, if it exists), the rotation angles, the directional cosine between both coordinate systems as well as the principal translatory stiffness.

4.8.1.3 Static determinateness and compliance with static limit values

After each calculation the program checks automatically, whether the system is statically determined, i.e. whether the weight as well as all applied static forces can be absorbed by the given isolators. If this is not the case, a corresponding message is shown. Before further results can be calculated, the static determinateness must be ensured. This is possible, for example, by adding further isolators.

At the same time it is checked whether the static limiting values of the isolators, input in accordance with section 4.6.4.5, are observed. If this is not the case, one receives a message which isolators exceed the limit values. If necessary one can display and compare the static values for the isolator with the input limit values. If another isolator shall be looked up in the database, it is recommended to enter the static load of the over-loaded item as the load parameter into the wizard for the vibration isolation. Then it can be considered during the database search.

4.8.1.4 Static displacements and loads

Static displacements and forces can be calculated for different objects of the model. The program considers the effects of all elasticities, the effect of the gravitational force in z-direction and the effect of static forces/torques. Additionally the constant parts of impulse and harmonic excitations are taken into account.

The button  switches off or on the calculation of the static displacement. This feature is useful for systems with automatic leveling (airsprings), where the static displacements are compensated automatically.

Static displacements of the center of gravity

In the window the displacements are displayed in the CCS. During model manipulations the window is automatically updated, so that one can for example move isolators or attach additional masses, until the tilts (angles of revolution Φ_X and Φ_Y) in the window become zero. Then for example the foundation is aligned horizontally. The results are available for all three centers of gravity (machine, foundation, total center of gravity).

Static displacements in points

In order to obtain values for the static displacements in any part of the model, one first inserts a point in accordance with section 4.6.8. If the values are to be calculated with respect to a direction deviating from the global axes, one rotates the point accordingly.

In the window the displacements are to be seen relative to the coordinates of the point. During model manipulations the window is updated automatically, so that one can, for example, move isolators or attach additional masses, until tilts (angle Φ_X and Φ_Y) become zero. Then the foundation is aligned horizontally.

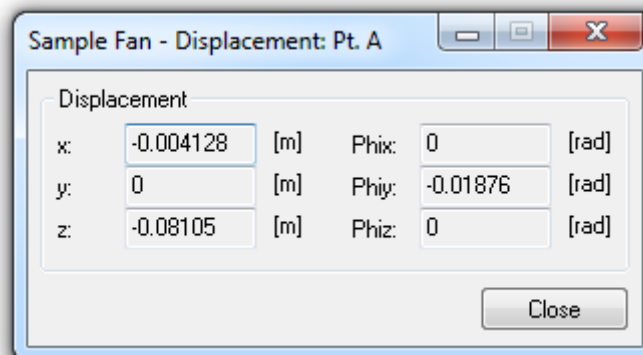

fig. 4.35 Result dialog for static results of point

Static displacements and forces in the isolators

The forces result from the product of stiffness and displacement (cf. section 3.1.4.2). The results for the reference point of the isolators are displayed (relative to RCS).

Ground load

In the object "Ground" (environment) the static ground load (total of all gravitational, static, and constant forces) can be displayed via the context menu. In the same window also the maximum values of the dynamic ground load are displayed.

4.8.1.5 Natural frequencies and natural modes

Using the menu "Results/Natural Frequencies..." a table can be opened containing the natural frequencies and vibration modes of the undamped system. This is shown in **fig. 4.36**.

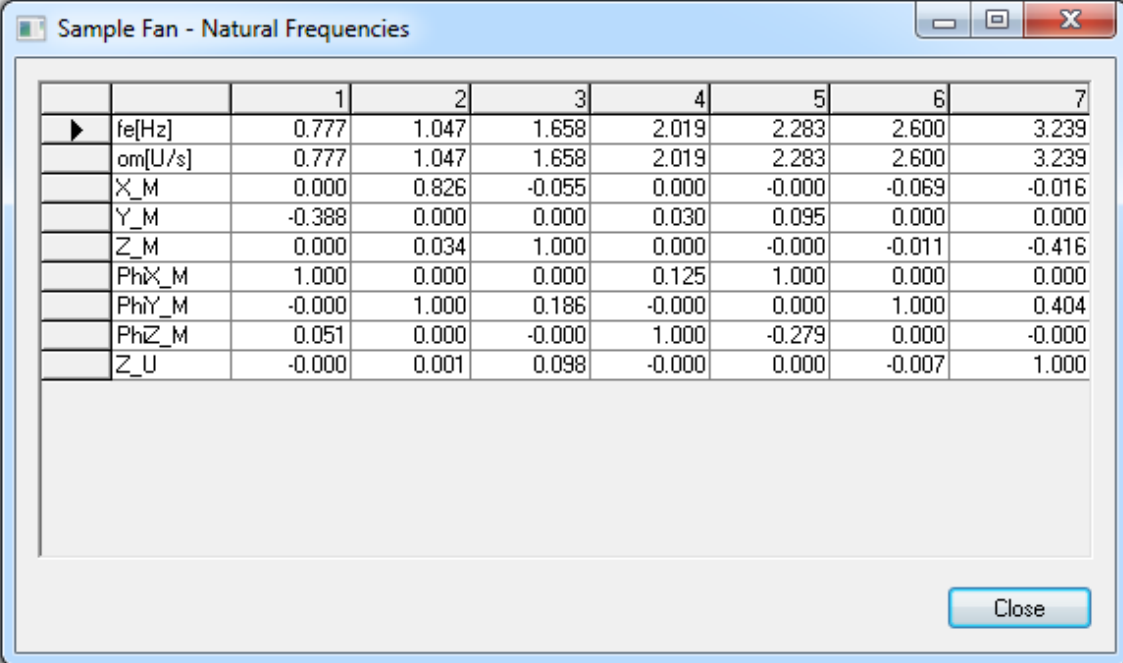

	1	2	3	4	5	6	7
fe[Hz]	0.777	1.047	1.658	2.019	2.283	2.600	3.239
om[U/s]	0.777	1.047	1.658	2.019	2.283	2.600	3.239
X_M	0.000	0.826	-0.055	0.000	-0.000	-0.069	-0.016
Y_M	-0.388	0.000	0.000	0.030	0.095	0.000	0.000
Z_M	0.000	0.034	1.000	0.000	-0.000	-0.011	-0.416
PhiX_M	1.000	0.000	0.000	0.125	1.000	0.000	0.000
PhiY_M	-0.000	1.000	0.186	-0.000	0.000	1.000	0.404
PhiZ_M	0.051	0.000	-0.000	1.000	-0.279	0.000	-0.000
Z_U	-0.000	0.001	0.098	-0.000	0.000	-0.007	1.000

fig. 4.36 Result dialog for the natural frequencies and eigenvalues/vibration modes

The components of the natural modes are indicated with respect to the CCS. Displacements are normalized such that the maximum value of each vibration is equal to 1. If necessary, a graphic animation of the vibration modes over the structure is possible in accordance with section 4.8.3. All non-zero natural frequencies are displayed. The window size can be changed at will, so that all numbers can be made visible.

4.8.2 **Dynamic results RCS**

Dynamic results are displayed via the context menu "Results Dynamic". They are shown in result windows (cf. section 5.3). If several objects are selected, then the quantities of all of these objects are transferred to one result window. Thus a comparison of similar results at different objects is possible (e.g. loads of the isolators).

4.8.2.1 Representation over the time

The time functions of the forces in the isolators and on the ground (environment) and time functions of displacements, velocities and accelerations at points and isolators can be calculated and displayed. Also one can plot excitations over time. Additionally, the functions integrated in the result windows permit the calculation of mean and

extreme values, which are of interest for the evaluation of the oscillations. You find details of result windows in the section 5.3.

The results are displayed in the coordinate system of the reference point (Reference coordinate system cf. section 3.1.6). For isolators the reference point is the coupling point.

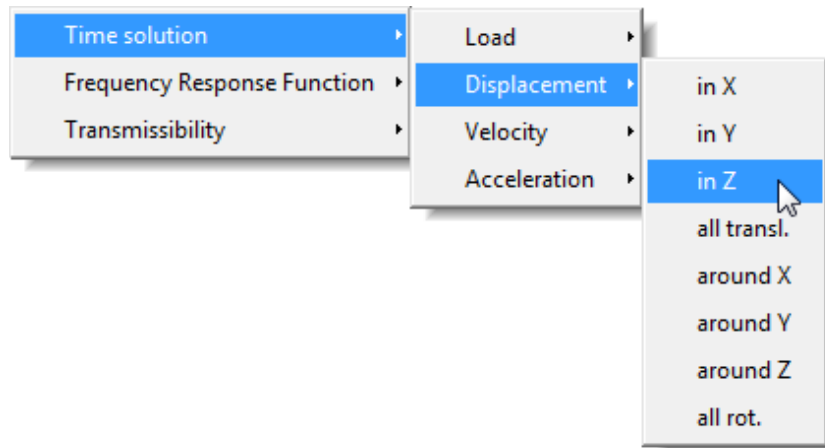

fig. 4.37 Representation of dynamic results over the time

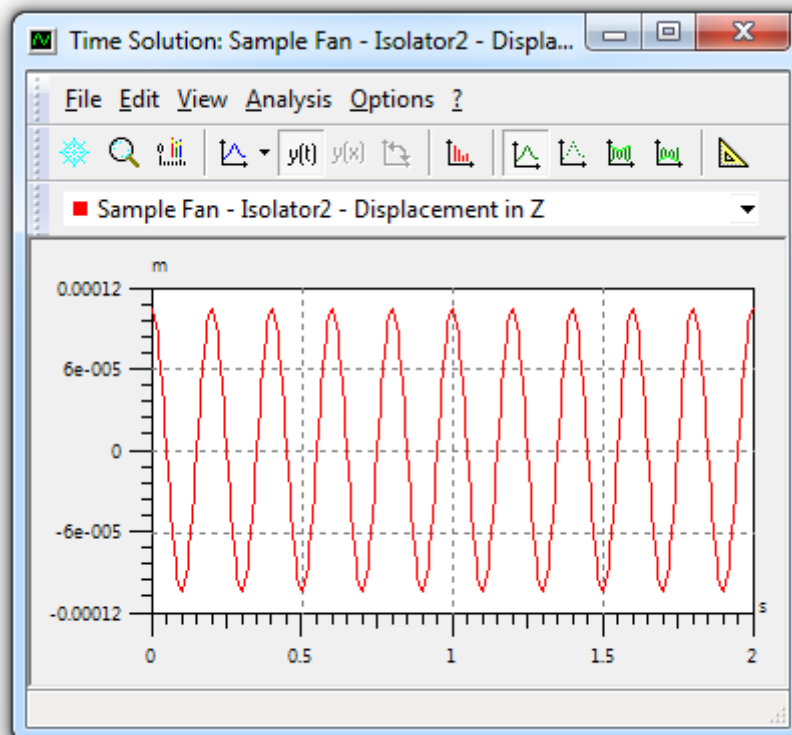

fig. 4.38 Representation of a displacement over the time

fig. 4.38 shows a displacement time function.

The time domain loads of the isolators are displayed without any static loads. This is reasonable as, otherwise, the static parts would mask the dynamic effects and little would be seen. If the maximum load is to be determined, static and dynamic parts must be added up. On the other hand, the maximum load is approximately equal to the static load (dynamic influences are isolated and negligible) if there is a good vibration isolation.

4.8.2.2 Representation over the frequency

Amplitude responses and transmissibilities can be displayed as function of the frequency. This applies to forces and displacements at isolators as well as to displacements at points. The frequency takes values within the range from 0 to the maximum frequency given in "Calculation/Settings...". The given frequency for each excitation is not considered in this computation.

The display of the results takes place in the coordinate system of the reference point (RCS, cf. section 3.1.1.7). For isolators the reference point is the coupling point.

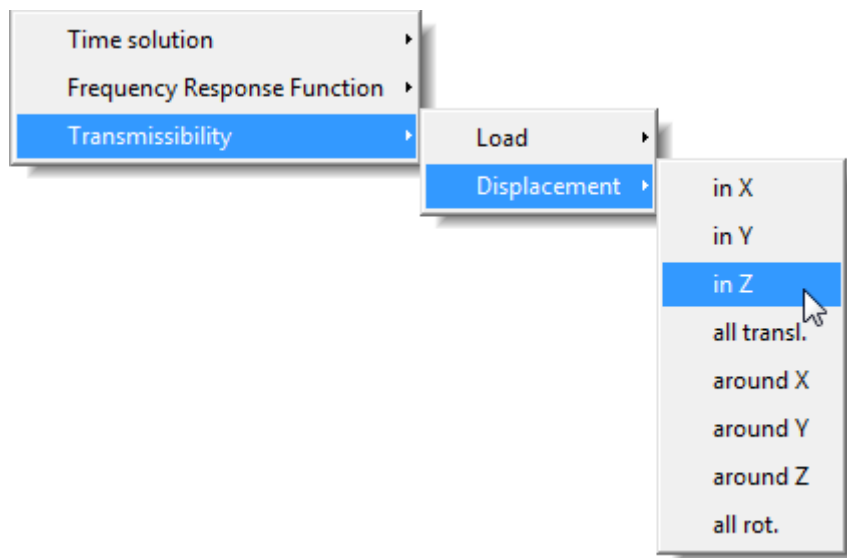

fig. 4.39 Representation of dynamic results over the frequency

Frequency response function

As described previously, the frequency response calculation includes the determination of the response amplitudes of the system for the given harmonic excitations. For points the amplitude responses of the displacements are calculated, for isolators the amplitude responses of the displacements and loads. The amplitude response at a certain frequency in the frequency represents the response amplitude of the system, if all defined harmonic excitations are applied at the same time with the given frequency.

Additionally, special transfer functions can be calculated by a suitable selection of the excitations. For example the dynamic flexibility is the displacement obtained from a harmonic excitation with the amplitude 1.

Transmissibility

The transmissibility is obtained from the frequency response functions (see above) derived, if these are normalized to their first value. This first value is calculated for the excitation frequency 0 Hz. This represents the case where all excitations are static. Thus the calculated transmissibility corresponds exactly to its definition and starts at 0 Hz with the value 1. The transmissibility is used, in order to check the compliance with the prescribed the degree of isolation. This is shown in the sequel.

Display of the achieved degree of isolation

The excitation frequencies are marked by perpendicular auxiliary lines, the required degree of isolation by a horizontal auxiliary line. The auxiliary lines are tagged in the properties dialog of the result window on the dialog page "Auxiliary Lines".

fig. 4.40 sketches the procedure for the check of compliance with the required degree of isolation. The transmissibility is shown. The required degree of isolation as well as the excitation frequencies f_{e1} and f_{e2} are marked.

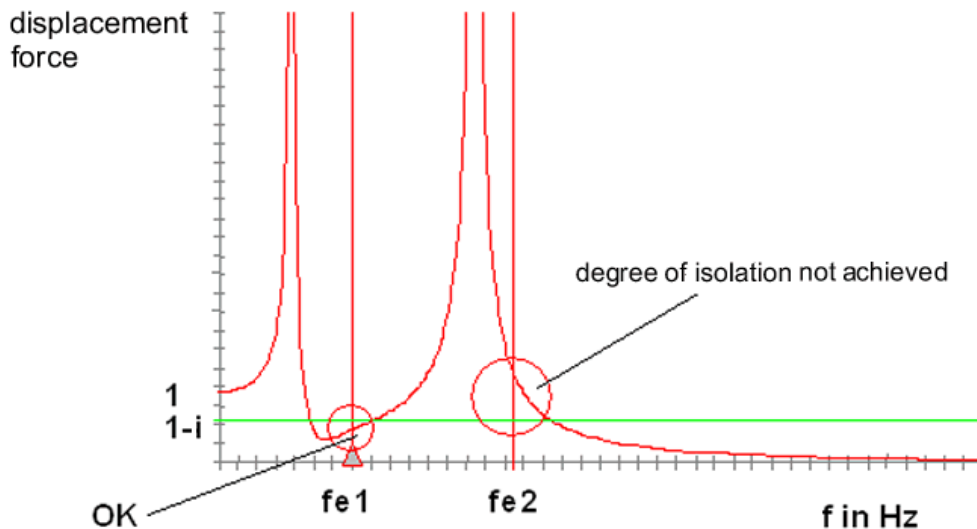



fig. 4.40 Check for compliance with the required degree of isolation

If one wants to perform a vibration isolation of machines, one displays the transmissibility for the load in the isolators, since it is a question of force excitation. If an isolation of devices is to be done or a ground excitation is present, one examines the transmissibility for the displacements, in particular for the center of mass in z-direction. This allows handling the cases of force and ground excitation (cf. **fig. 1.1**). In both cases it is the aim of the vibration isolation, that the transmissibility in the excitation points (marked by perpendicular lines shown) reaches or exceeds the desired degree of isolation (horizontal line). This implies that all vertical lines cross the

transmissibility function below the horizontal line. In **fig. 4.39** this is achieved only for the first excitation frequency f_{e1} .

If one requires the transmissibility of the displacement for an arbitrary point, one places a point in the desired location (section 4.6.8) and activates its display. The transmissibility for any direction in space can be calculated by rotating of the point.

4.8.3 Freezing result curves

For all results mentioned in section 4.8.2 the plotted curves can be 'frozen'. This allows to observe the effect of changes to the model itself or to the model parameters. By clicking the button  the active (selected) curve is tied to the display and remains unchanged during recomputations of the project due to model or parameter modifications (cf. section 5.3.1.1).

4.8.4 Animation

The static displacement, the vibration shape and the natural mode shapes can be animated. The animation is started and terminated via the menu "Results" or  in the toolbar. At start a dialog is opened, in which the properties of the current animation can be changed (**fig. 4.41**).

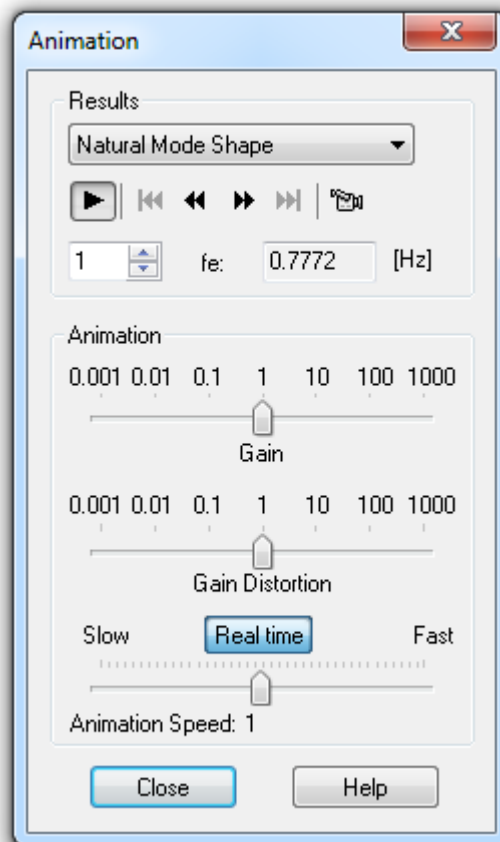

fig. 4.41 Dialog for the adjustments of the animation

In the upper area of the dialog, the animation kind can be selected. Using the buttons below the animation can be stopped or stepwise executed. You can export the animation as a video file too (see section **4.8.5**).

The sliders in the lower area allow the scaling of the results and the animation time. Note that the "Gain" affects translation **and** rotation. The "Gain Distortion" affects only the rotation coordinates.

Closing the dialog does not terminate the animation. During a running animation all manipulations in the views or in the model are still possible. The results are updated automatically. This is in particular helpful for the horizontal alignment of the machine.

Static displacement

If one selects this option, the static displacements of the rigid body are displayed over the structure in the proper scale. The weight of the body and the given static forces act as static loads (cf. section **4.8.1.4**). Since only in this case the static state and no transient behavior is shown, the animation control buttons are disabled.

Operation vibration shape

With the animation of the operation vibration shape the time functions of the displacements according to section **4.8.2.1** are displayed over the structure. If the excitation is purely harmonic, the representation corresponds to the stationary vibration state. With a purely transient excitation one obtains the impulse response over the time.

The duration of the animation corresponds to the end time of the computation (**section 4.7.1**). The lower limit of the time scaling is bounded by the resolution of the time results (**section 4.7.1**).

The frame rate for the animation is set to ca. 30 frames per second. Hence in real time only frequencies up to 15 Hz can be displayed. In order to avoid undersampling effects, you should select an appropriate scaling factor.

Natural mode shape

At a time one can animate one of the natural modes in accordance with **4.8.1.5**. Its order is entered in the dialog (**fig. 4.41**). Using the plot you observe very easily, how the system oscillates in the respective frequency, which isolators are heavily stressed at this frequency, and thus substantially determine this frequency. From this can be followed, which isolators must be changed, if necessary, in stiffness and position.

4.8.5 Video Export

Using the button  of the animation control the animation sequence can be exported as video file. There are several options for the video generation. In any case the currently selected vibration mode is exported. The static displacement cannot be exported, use the picture export in this case (menu "Edit/View to Clipboard" instead).

For the video export the start and end time can be set. For the animation of the vibration shape the values from the "Calculation/Settings..." are used by default. By changing these values only a cutout of the animation can be exported. For export of the natural mode shapes **ISOMAG** animates one complete oscillation within 2 seconds.

The Speed defines how long the selected time span takes on the video. With a defined time span of 2 seconds the video has a length of 2 seconds with speed value of 1 and 4 seconds if speed equals to 0.5.

Changing of the frame rate has no effect on length of the video, but on the number of single images which are displayed in one (video-) second. This setting affects the time which is needed to generate the video, but should not be too small in order to avoid undersampling (see section above). If the frame rate is too small a warning is shown.

The Resolution can be chosen arbitrary. The default value is the current **ISOMAG** window size.

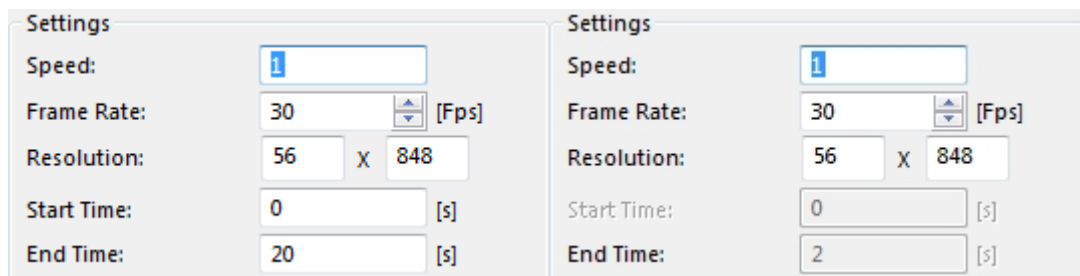



fig. 4.42 Video export settings. Left: Vibration shape, right: Natural mode shape.

4.9 Documentation

In order to document the results, a special program is used: the Print Designer. It is called from **ISOMAG** via the menu "File/Page Preview...". Via "File/Print" a Print Designer document is created and printed in the background. In **ISOMAG** as well as in the Print Designer the user can adapt the printer settings via the Windows standard dialog "Print".

Detailed explanations concerning this program are found in **section 5.4**.

4.10 Useful notes/Troubleshooting

Problem	Solution
There are long response times after modifications of the model.	The computation of the results may take a longer time for larger models or a small time step size according to section 4.7.1. Change the calculation settings or switch off the automatic recalculation and calculate only when all modifications are done.
During printing the Message "Server is busy " appears.	Wait a moment and then click on "Repeat". Reduce memory usage (open only one model, close other applications, increase the real or virtual memory).
When selecting items by means of a rubber frame too many or no elements become selected.	Check and correct the status of the buttons "... selectable" in the Object toolbar Select the desired items in the tree view.
Calculation results do not appear in the result printout.	Only natural frequencies, principal moments of inertia, and principle stiffnesses, and static results appear automatically in the print. Other results must be present as opened (maybe minimized) window.
The 3D-Graphic is incorrect or incomplete.	Install the most current OpenGL display driver for your graphics adapter. Reduce the 3D-Hardware acceleration of the graphics adapter. Switch from in menu "View" from "Four Views" to "One View" mode in menu. Open only one model.
There are too many coordinate systems visible.	Select the unwanted coordinate systems in the project tree and switch their visualization mode to "Invisible" using the context menu. Use the button  to switch off the visualization of the result coordinate systems for main stiffness and main inertias. Markieren Sie im Projektbaum die unerwünschten Koordinatensysteme und schalten Sie sie via Kontextmenü-Visualisierung unsichtbar.
Toolbars are not visible completely.	Move the Toolbars to another place. Switch off some Toolbars (click with the right mouse button on a Toolbar).

Problem	Solution
The printout is to be modified before printing.	Over "File/ Page Preview" the Print Designer is started and a preview is generated. In the Print Designer the document can be modified. For the archiving of the results the Print Designer file can be stored also. If the capabilities of the Print Designer should not be sufficient, then items of the view can be inserted into other Windows applications, completed there, and the result again be inserted into the Print Designer.
In the database isolators of a certain manufacturer were searched and nothing was found. A new search with other manufacturers is not possible, since only one manufacturer is displayed.	The modifying/inserting of search conditions always forms a subset of the current set of objects. In order to search the complete database again, all search criteria have to delete and the complete set has to be recalled via "Start". Then new conditions can be generated.
Texts in the status line are truncated.	The current screen resolution is lower than 1024 x 768. Increase the screen resolution.
In the result printout the graphic is missing.	<p>There is not enough free memory. Close other applications if possible.</p> <p>There is an error in your display driver. Proceed as in "The 3D-graphic is incorrect or incomplete."</p> <p>Copy the view to the clipboard (menu "Edit/View to Clipboard" or create a screenshot (Alt+Print for the active window or Ctrl+Print for complete screen). Insert the screenshot into the Print Designer via the Clipboard.</p>
The 3D-Graphic is slow	ISOMAG uses the 3D graphics library OpenGL. A graphics adapter with 3D hardware acceleration is recommended. Make sure that you use the most recent driver for your display.
ISOMAG is unstable.	There is not enough work memory available. Close other applications if possible.

5 Special program modules

In the following section special program modules are described, which are not a part of **ISOMAG**, but are started from within the application:

- Database selection
- Characteristic curves
- Result windows
- Print Designer

5.1 Database selection of isolators

By means of the wizards for simple and double vibration isolation (Menu "Calculation") one reaches an extensive isolator database, which is linked to the program (**fig. 5.1**). With the results of the dimensioning calculation described in the section 4.7 those isolators are selected, whose dimensioning stiffness (c_{Ausl}) in z-direction is smaller than the required stiffness and whose maximum force in z-direction is larger than the maximum load.

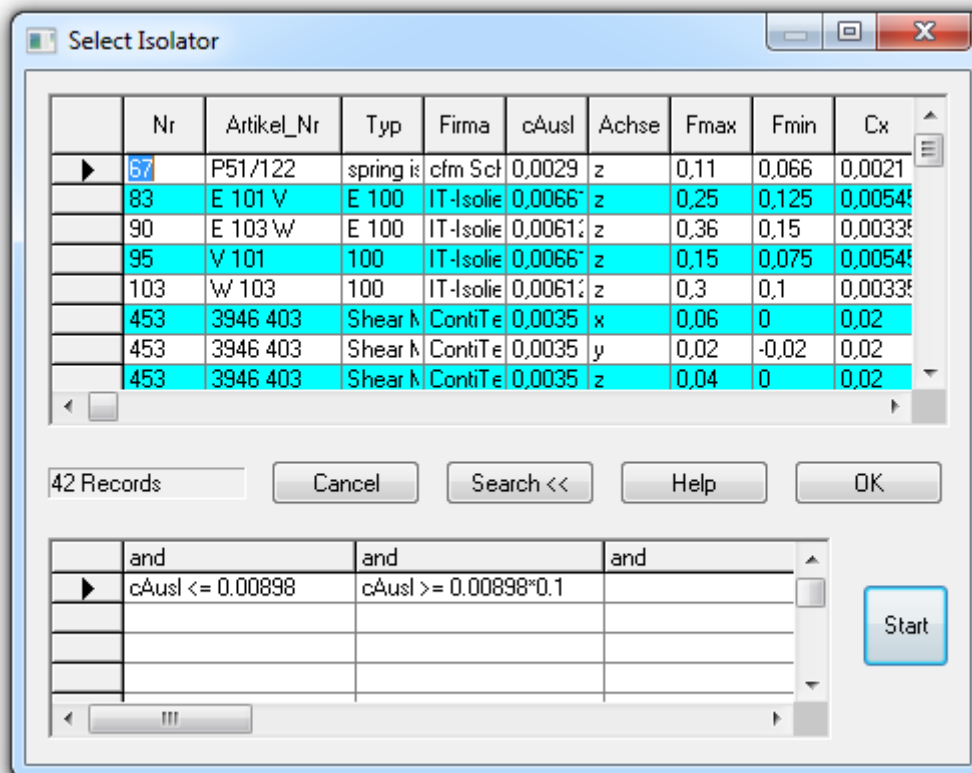

fig. 5.1 Database connection for the selection of isolators

By one click on the heading of a column (result table) one can sort its contents in ascending or descending order. The catalog display contains four buttons. With "Cancel" you terminate the selection without importing data. With "OK" or a double click

on a line the selected data record is assigned to the isolator(s). The selected record is indicated by the tag - a small black triangle - on the left side.

The "Search <<" button shows the condition table which is not visible at the beginning. In the table those conditions are visible, which led to the current result. The search criteria can be modified. For example it is possible, to consider only isolators of certain manufacturers.

If one double clicks on the right border line in the heading of the result or condition table, the program automatically selects the optimal size - depending on the longest entry in each column. Additionally it is possible, to adjust the width of the columns by manual dragging of the border lines.

The program interprets the condition table according to the following rules (**fig. 5.2**)

1. Conditions of one line are connected by logical AND.
2. The lines of the table are by OR.

B11	B12
B21	B22

= (B11 UND B12) ODER (B21 UND B22)

fig. 5.2 Rule for the analysis of the condition table

In order to input search criteria, you click on the corresponding box - a button with a small black triangle appears. A click on the triangle opens a further window (**fig. 5.3**), in which the conditions can be entered.

fig. 5.3 Input conditions

Field name: Select the box for the input condition.

Relation: available are =, <, <=, >, >=, between (between Value1 and Value2)













Value: Either specify the value (or a formula, from which the value results) for the search here or use the combobox, in order to select a value from the database. With "OK" the dialog is closed, and the input parameters are activated in the main dialog.

If you entered all conditions, start the database search with "Start". The number of data records, for which fulfill the selection criteria, is displayed. After the selection of an isolator on "OK" - the dialog will be closed, and the data will be transferred to wizards or assigned to the selected isolators.

5.2 Characteristic curves of the force displacement

Nonlinear stiffnesses of isolators can be considered in the program by force displacement characteristics (F-s characteristic curves). For the input (or display) one selects the characteristic curve in the parameter dialog (dialog page "Stiffness" checkbox "Curve"), and presses "Edit...", which opens the curve editing window (**fig. 5.4**).

The dialog enables the comfortable input of a F-s characteristic curve, either numerically or graphically. The buttons of the Toolbar have the following functions:

	Load curve		Linear interpolation*
	Save curve to a file		Spline interpolation*
	Print curve		No special treatment*
	Insert a new line after the current line		Reflect curve*
	Delete the current line		Repeat curve*
	Stair case function*		Linear/no extrapolation

(*) Examples are given in the sequel.

Examples:

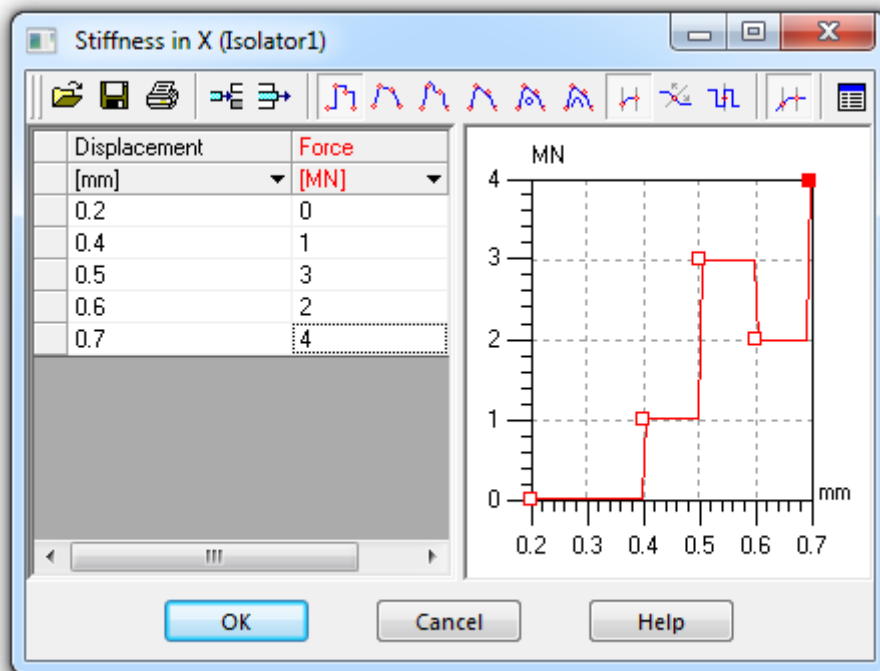

fig. 5.4 Staircase function

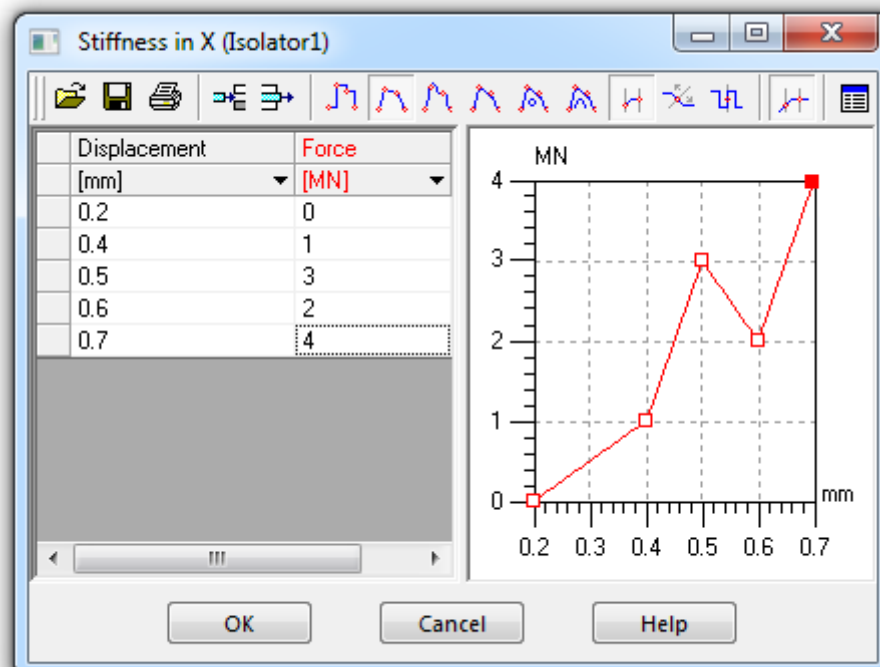

fig. 5.5 Linear interpolation

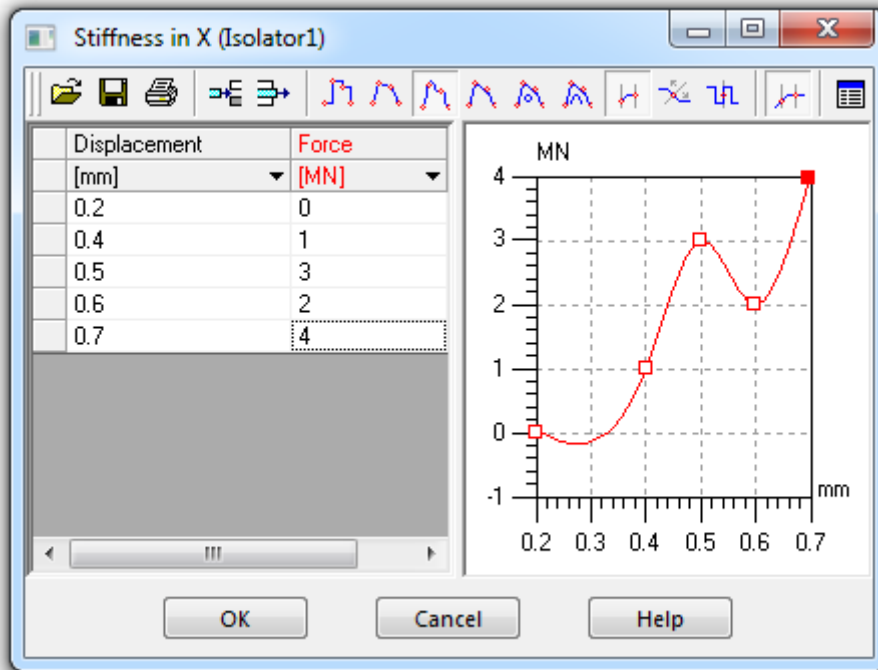

fig. 5.6 Spline interpolation

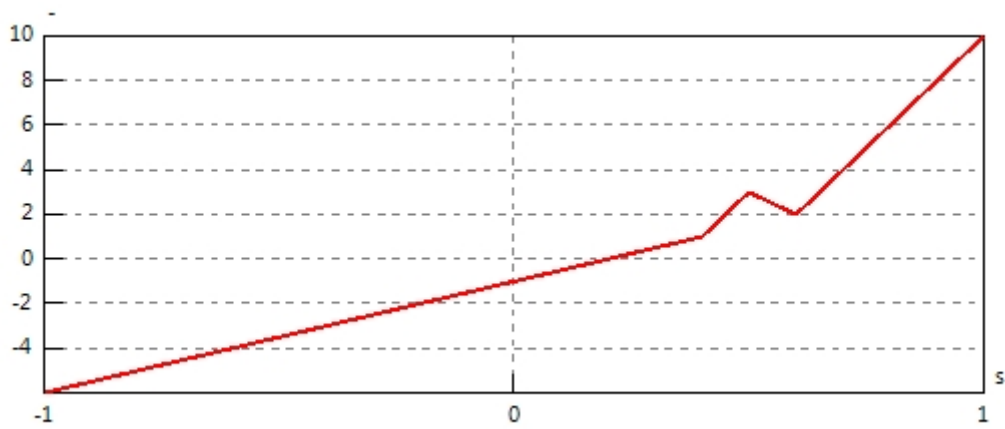

fig. 5.7 No special treatment

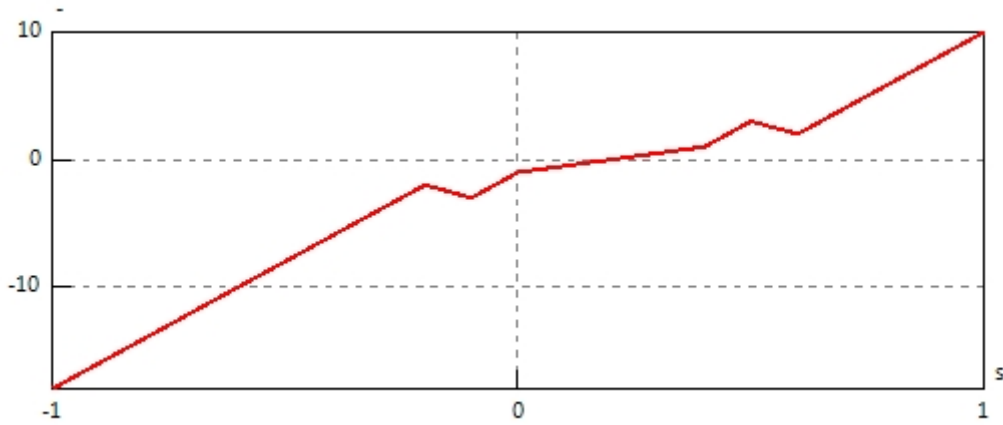

fig. 5.8 Reflection

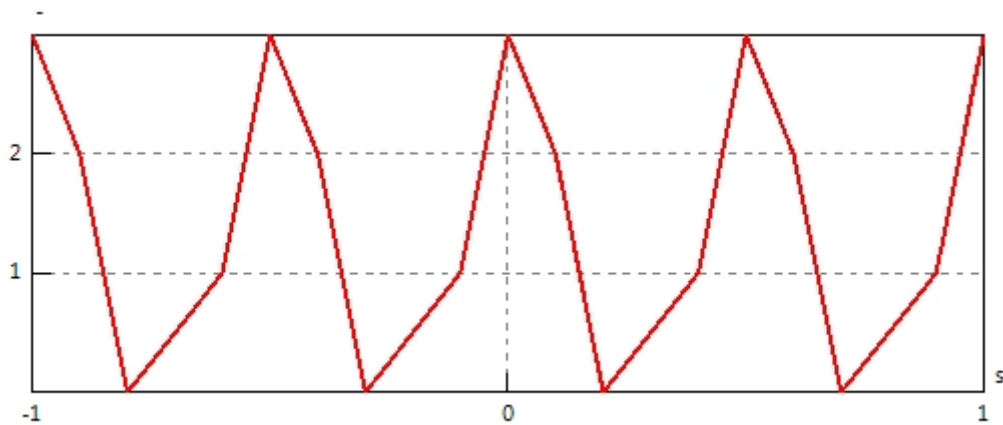

fig. 5.9 Curve repetition

Within the table the values of the characteristic curve can be edited freely. The following keys have special functions:

TAB	Moves the cursor to the next row
SHIFT+TAB	Moves the cursor to the previous row
ESC	Closes the curve window and drops the changes
ENTER	Terminates the current editing process

Arrow keys ↑ Moves the cursor one column up or down
and ↓

Arrow keys ← Moves the cursor within a line to the left or to the right
and →

You can select a line by one mouse-click on the first column (cursor changes to a black horizontal arrow). If you move the cursor behind the last line of the table, a new line is appended automatically. The current characteristic curve is displayed in the preview. The point selected in the table is highlighted in the diagram too.

It is also possible to manipulate the characteristic curve interactively in the graphic by selecting and dragging a point. You select a point and track it. The following keys have a special function during the manipulation with the mouse:

SHIFT The mouse can only be moved in y-direction, the x-value remains constant

CTRL The mouse can only be moved in x-direction, the y-value remains constant

A double click into the preview diagram creates a new point. A double click on an existing point deletes it.

The characteristic curve describes the force displacement characteristic inside the isolator. Pressure forces are positive. The forces and displacements are positive for pressure loads and thus have the opposite orientation of the element coordinates. If the characteristic curve is described only for the pressure range (for positive forces and displacements), then it is reflected automatically by the program and used also for the tension force area if necessary. If the characteristic curve has a different shape for tension and pressure, it must be entered completely. If the item is not to be exposed to tension forces, this must be described explicitly by at least one point on the negative x axis (if linear extrapolation is selected). If extrapolation is not used, and the domain of the curve is exceeded during calculation, a message appears and the calculation is canceled.

5.3 Result windows

The result windows display functions of the time or frequency. The freely sizeable windows provide various menu instructions and control elements (**fig. 5.10**). Result windows are opened via the context menu "Results/Dynamic/..." of the respective objects.

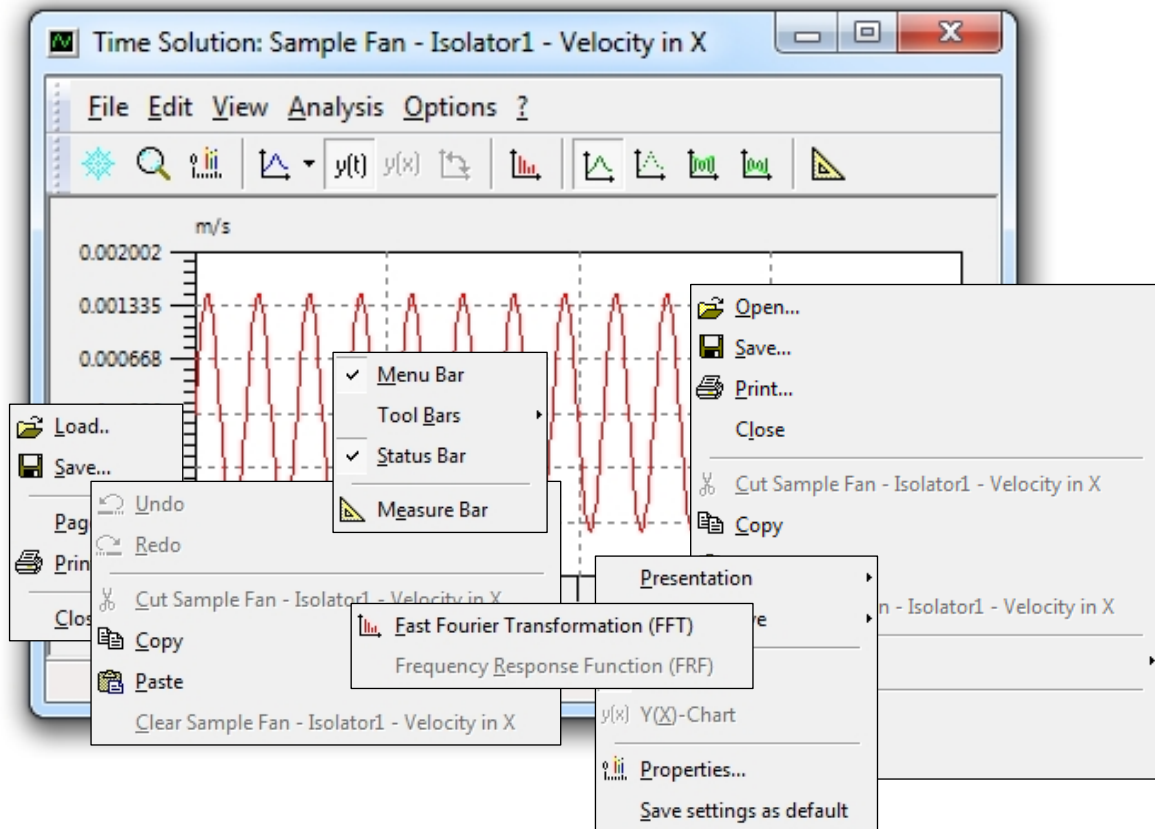

fig. 5.10 Result window overview

The most important commands are multiply available (Menu, Toolbar, Popup-Menu). Thus the operation is permanently ensured, even if Menu and/or Toolbar are switched off. In the following the individual functions are described.

5.3.1 Menus und toolbar buttons

5.3.1.1 File menu



Freezing of the selected curve. During a recomputation this curve remains unchanged and can be compared to new results.



Save all curves in one of the following formats: Text, CSV, IEEE binary, ITI binary, ITI ASCII, DIAdem header file.

Page settings: opens the dialog for the adjustment of the page layout. Here you can select size of the paper and the paper source, and the orientation (portrait or landscape format), and the page margins. These adjustments concern only the printing of the results.



Print all results represented in the window. The diagram is scaled on the page size. That means, it is reduced or enlarged until one edge (width or height) fits the paper size.

5.3.1.2 Edit menu



Copy the current curve (triangle in the legend) from the result window into the Clipboard. The transfer takes place in three formats:

- an internal format for **communication** of the result windows among themselves,
- a text table with rows and columns,
- a graphic (Windows Metafile WMF file).

Another applications can select the desired format via "Paste as...".



With **cut** the current curve is removed from the result window and stored into the Clipboard (cf. copy).

5.3.1.3 Options menu



y(t) Chart: A result is represented as time function. If several result curves with different physical meaning are displayed in one window for each, result a new y axis is created automatically. The assignment of the respective axis to the result is made by sorting of the units according to the legend. For the x-axis this holds equivalently.



y(x) Chart: If in a result window **an even number** of result curves is shown, every second can be displayed over the preceding one. The axes can be exchanged using the button "Exchange axes".



Frequency analysis (FFT): calculates an amplitude response as a function of the frequency for a given signal (y(t) chart) and displays it in a new window. All FFT result windows are closed after a recalculation.

Frequency response function (FRF): If an even number of curves (y(t) chart) is displayed in the result window, one can determine a **complex transfer function** using this instruction. The result is displayed in a new window. All FRF windows are closed after a recalculation.



Zoom: cf. section **5.3.3.5**



Properties: cf. section 5.3.2.1

Save Settings as default: With this instruction all settings are stored in accordance with **section Fehler! Verweisquelle konnte nicht gefunden werden.** and used for all further result windows. The stored settings are still available after a restart of the program.



Polar coordinates: Use this instruction, in order to represent a result in polar coordinates. Now the phi axis corresponds to the x axis and the r-axis to the y axis. In this representation measuring it is not possible.



Bar chart: This instruction activates the representation of the results in a bar chart. Each result corresponds to a bar; therefore one only obtains useful representation, if several results are to be displayed in the same chart. In this representation measuring it is not possible.



Line (default): The curve is displayed as line.



Points: Only the points at which results are really computed are displayed.



Upper Envelope: The upper envelope (connection line of local maxima) is shown.



Lower Envelope: The lower envelope (connection line of the local minima) is shown.



Measurement: Opens the measurement window.

The setting refers to curve which is currently active.

All kinds of result visualization can be used simultaneously. If all buttons are switched off the curve is hidden which can be used for a temporarily suppressing of a result curve.

5.3.2 Curve



Each result window and therein each individual curve can be adapted to your needs by modifying numerous characteristics. For this the dialog "Options" shown in the following pictures is opened (Menu "Properties", context menu or Toolbar).

5.3.2.1 Window properties

fig. 5.11 shows the dialog page for the adjustment of the characteristics, which refer to the total window. Here you determine the color of the window background as well as of the display area for the curves itself. Keep in mind to balance these colors with

those of the curves (cf. section 5.3.2.3). For the grid the color as well as different line types and widths are selectable

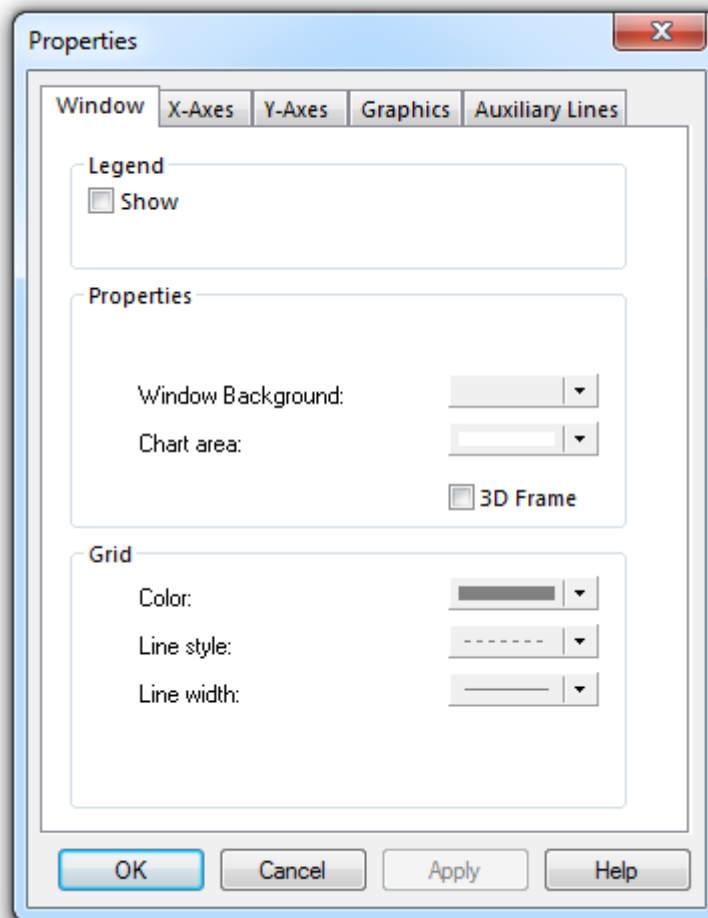

fig. 5.11 Dialog Properties, page "Window"

5.3.2.2 Properties of the axes

X and Y-Axis have the same properties, which are adjustable separately. **fig. 5.12** shows exemplarily the dialog page for the y axis. The x-axis is parameterized in the same way.

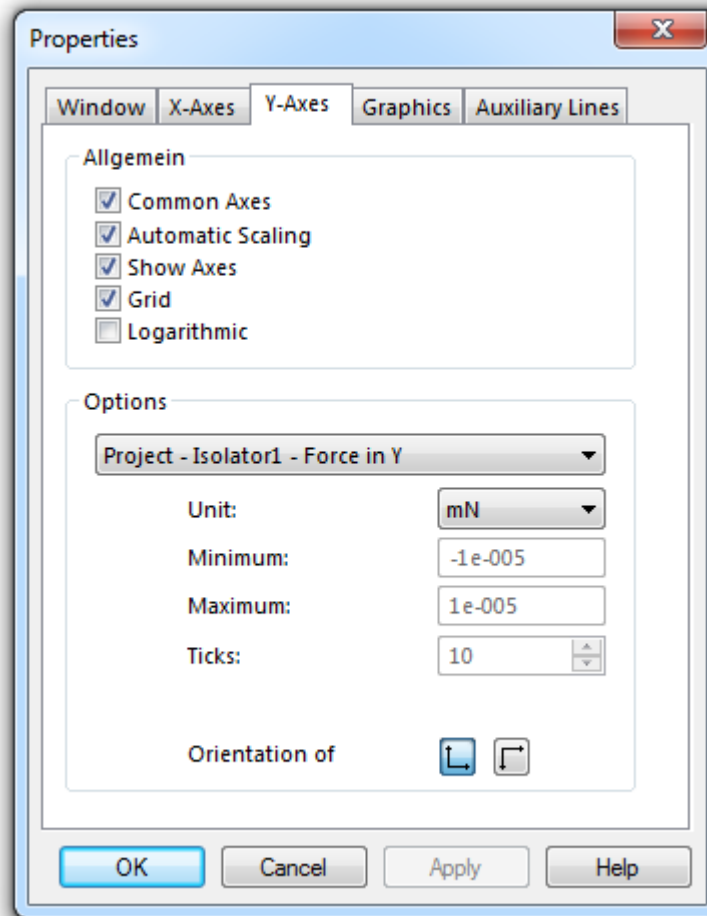

fig. 5.12 Dialog Properties, page Y Axes

If the result window contains several curves, a **Common Axis** can be used for each coordinate (X, Y). Otherwise each curve has its own axes, which are separately adjustable. If **Automatic Scaling** is selected, the axes are adapted such, that all values are shown. In this case minimum, maximum, and axis ticks are no longer changeable.

The axes can be shown ore hidden using the **Show Axis** checkbox. Selecting **Grid** the axes are divided into sections and ticks are shown. The number of ticks can be changed.

Special features:

- Additionally the **Orientation of the Y-Axis** (upward or downwards) can be selected by clicking the corresponding button.
- If the result window contains a plot in polar coordinates, the properties dialog adjusts the Phi- and the R-Axes instead of the X and Y-Axis. Unused parameters are hidden. The **Phi-Axis** permits the adjustment of the position of the origin in degrees in the mathematically anti-clockwise direction. The **R-Axis** requires the specification of the empty area in the center of the diagram.

5.3.2.3 Properties of the curve display

The color and line style, in which the curves are drawn, as well as the color of the background are preset by the system (first curve red, second green, third blue...). This can be changed by the user on the dialog page "Graphics" (**fig. 5.13**). The button "Font..." opens the Windows standard font dialog. The selected font is used for inscriptions in the result window. In order to adapt the curve plotting, you proceed as follows:

1. Select a curve from the listbox.
2. Determine the desired properties by means of the controls.

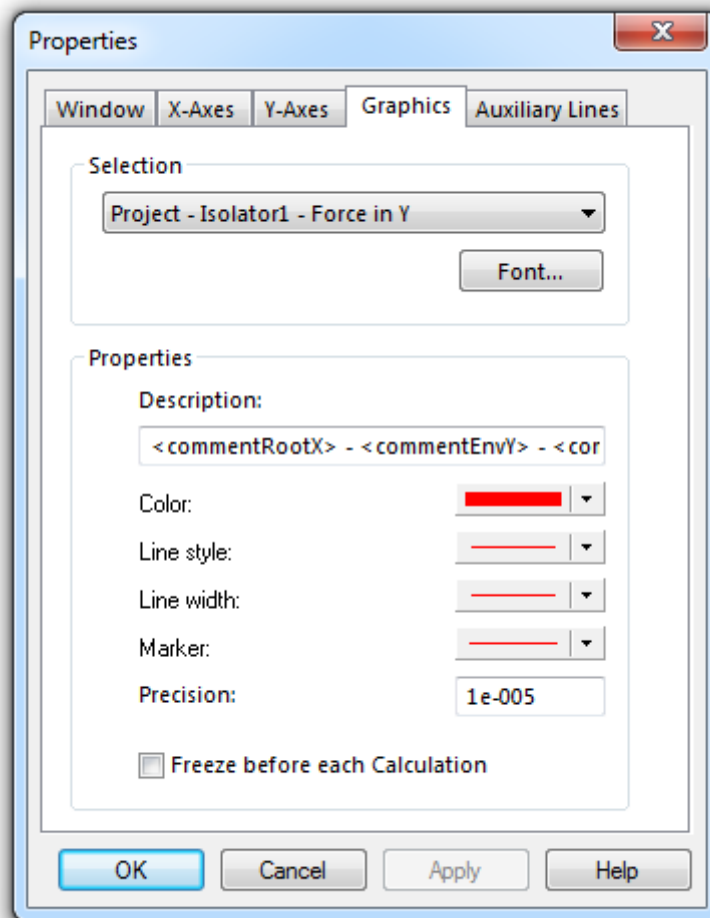

fig. 5.13 Dialog Properties, page Graphics

Markers are assigned to every point of the curve. That means, this selection is only practical if the number of points on a curve is not too large. If you click the checkbox "Freeze before each Calculation" the selected curve remains unchanged during the following computations.

Finally there it is possible, to work with auxiliary lines (**fig. 5.14**). Auxiliary lines for the Minimum, Maximum, Mean and RMS are predefined. Further auxiliary lines can be

added and deleted as required. The color, line type and width of lines can be changed.

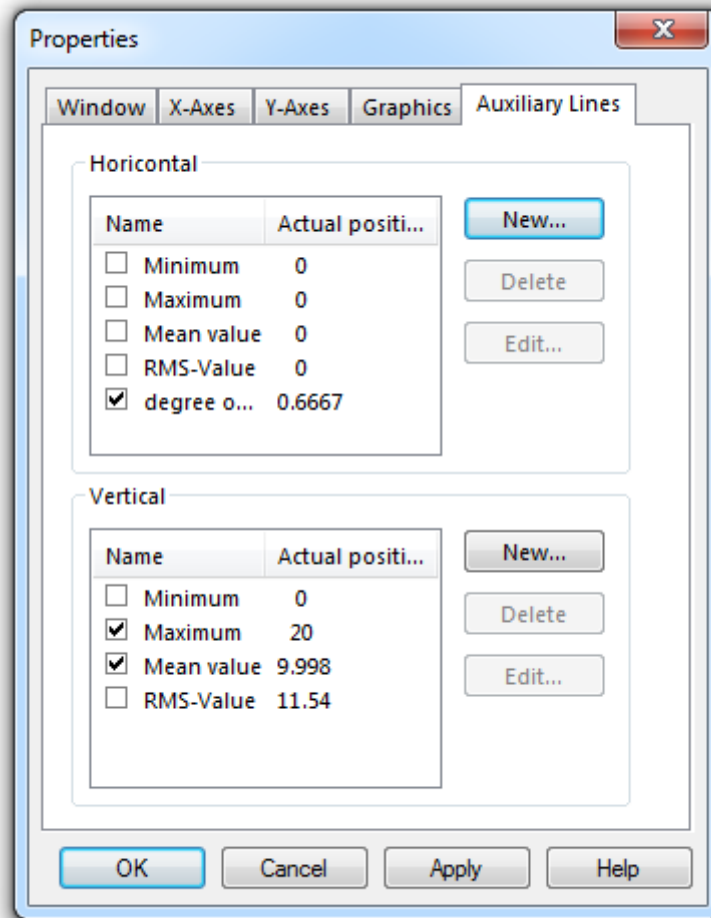

fig. 5.14 Dialog Properties, page "Auxiliary Lines"

Some result windows contain automatically predefined auxiliary lines (frequencies of harmonic excitations, degree of isolation).

5.3.3 Further functions

Furthermore there are some functions available, which are not visible at the first sight. They are described in the sequel.

5.3.3.1 Current result

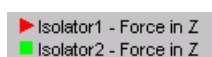

The legend (on the top right in the result window, can be switched on using "Settings/Window/Legend) contains all results in the order in which there were added to the window. The **selected curve** has a **triangle marker** and is also selected in the listbox of the toolbar. In order to make select another curve, you have to click on the small square or to select it from the listbox. Switching also is possible by means of the "TAB" key. If there is more than one curve, all actions (cut, deletion out, measuring etc..) refer to the selected curve.

By clicking on a marker with the right mouse button on a marker, a pop-up menu for the selection of a new color for the corresponding curve is opened.

In case of multiple Y-axes are shown, the labelling of these axes is in the same vertical scaling as the legend. By this, the correlation of the respective result and the corresponding axis is ensured.

5.3.3.2 Rename gradients and curves



The curves in the result window can be renamed. To do this, open the “Properties” window of the result window with the button  and switch to dialog page “Graphics”. Choose the regarding curve in the „Selection“ field and enter the preferred name in the „Description“ field. The following keywords can be used for the input, which will be changed by the program:

Table 5.1 Keywords for labelling of curves

Keyword	Relevance
<commentEnv>	name of object
<comment>	name of result

By this, frozen gradients as well as curves loaded from data files can be labelled sufficient.

5.3.3.3 Modifying Units

 If one clicks with the right mouse button on the unit of an axis, one opens a pop-up menu with all possible units for this axis. The selection of a new unit switches the display and all values are converted.

5.3.3.4 Value display

In the graphical representations $y(t)$ and $y(x)$ the values of the function at any point of the curve can be extracted and displayed. For this one moves the mouse pointer into the diagram and presses the left mouse button. The cursor transforms into a crosshair and marks the current mouse position. In the Status bar the values corresponding to the mouse position are shown **fig. 5.15**. If one moves the cursor along the function with the left mouse button pressed, the values are updated. If the Status bar is switched off, a small window with the current values, which moves together with the hair cross, displays the current values. Only **calculated points** are displayed. This means, if the function contains for example only a few values, the hair cross jumps from point to point.

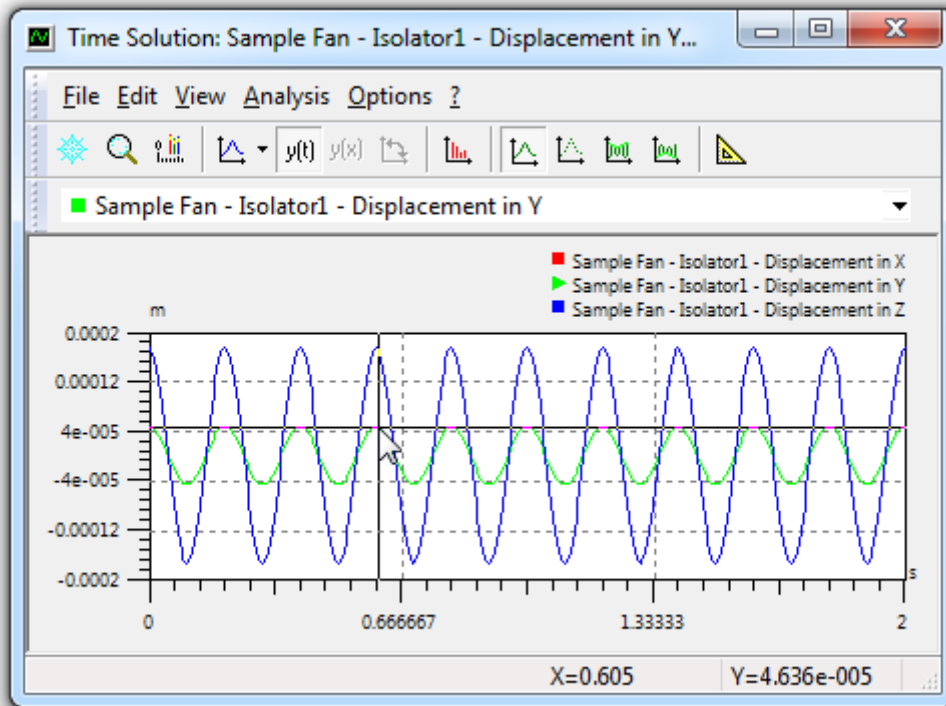

fig. 5.15 Result window with value display

Two modes are to be distinguished:

1. In the $y(t)$ representations the hair cross sticks to the selected curve.
2. In the $y(x)$ representations the hair cross moves freely. That is necessary; in order to measure not biunique points (loops). The display areas contain the values corresponding to the current mouse position. In order to achieve a higher accuracy, one can zoom the window.

In addition you can enable a much more convenient function by actuating the button  („Measure“).

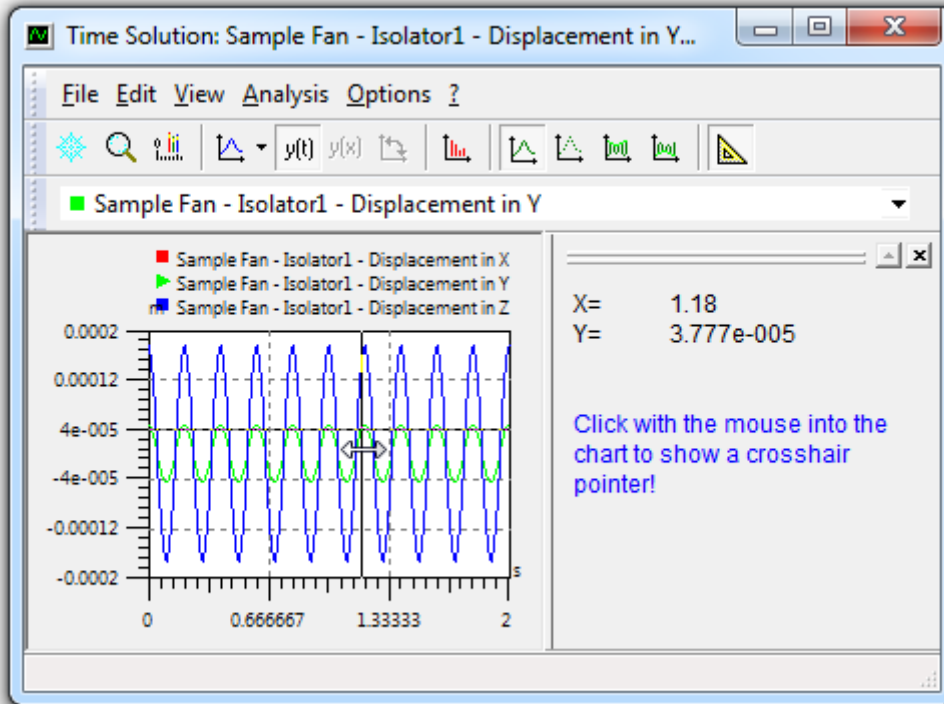



fig. 5.16 Result window with activated measuring window

On the right window side a display field shows various values. You get a first hair cross with the first mouse click on the diagram area. You get another one with a second mouse click. The vertical lines of the hair crosses can be shifted with the mouse. The values in the display field are updated accordingly. To copy the values to the clipboard use the right mouse button.

To finish the measuring function push the button  again or close the display field.

5.3.3.5 Zoom

Of course one can have a closer look at a section of the curve. In alternative to an adjustment of the minimum and maximum in the properties dialog (**fig. 5.12**) a section can be selected interactively by means of the zoom function. For this one clicks on the magnifying glass in the Toolbar (Menu "Options/Zoom") and draws a rectangle bounding the area of interest.

If the selection has to have exact bounds (e.g. for documentation purposes), the input of minimum and maximum should be preferred (switch off Automatic Scaling!).

By double-clicking on the display area one returns to the original display (complete curve). This reactivates automatic adaptation of the axes.

5.3.3.6 Drag&Drop of results

 The result curves have a Drag&Drop mechanism. One can pick them up and move them. For this one touches the desired curve with the mouse:

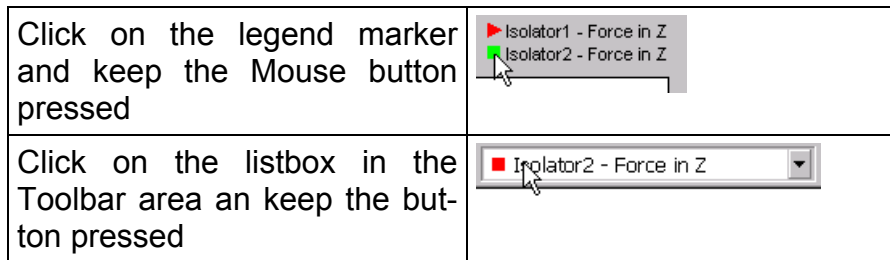

With a result "glued to the pointer" then the following actions can be executed easily and rapidly:

Move the result: Drop the result over the target result window (release the mouse button). The moved curve is displayed together with the already existing functions in the window.

 **Copy the result:** Additionally press the Ctrl-key (cursor gets a plus) and drop result over the target result window (release the mouse button). The copied curve is displayed together with the already existing functions in the window.

 **Delete the result:** Via the context menu the selected curve can be deleted from the result window. It is also possible, to drop the curve into the (Windows-) waste basket (release the mouse button).

5.4 Print Designer

The log printing does not take place directly in the program **ISOMAG**. The menu "File/Print" starts the Application "Print Designer" and initiates the log printing. The complete log contains successively the following sections:

- General specification
- Model views
- Parameters of the objects
 - Environment
 - Machine
 - Foundation
 - Isolator
 - Excitation
- Results

5.4.1 Outline

The Print Designer is a separate tool for the organization of the output log. This OLE container application administrates diverse objects on a worksheet (document) (cf. **fig. 5.17**). The output log is created using a pre-defined template. This template can be adapted to special demands. The handling of this tool will be explained on the base of some fundamental questions.

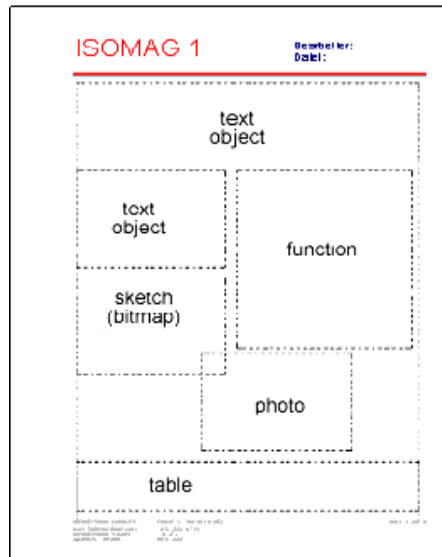

fig. 5.17 Example for an output listing

How do the objects arrive on my worksheet?

1. The most important source is the program **ISOMAG**. If you execute the instruction "Print" or "Page Preview" there, an output log is generated, that contains the above mentioned objects.
2. Another source is the Clipboard. If it contains suitable objects, e.g.
 - a previously copied object,
 - contents of a result window,
 - a bitmap from a paint program,
 - objects from CorelDraw or briefly spoken,
 - objects from all OLE capable applications,
 the object can be inserted before a selected object or at the end of the worksheet using the "Edit/Paste" command.
3. A third possibility is given with the instruction " Edit/ Inserts new object... ". This activates Windows mechanism for inserting OLE Objects into documents (cf. Windows on-line help).

How is an object deleted?

Select the redundant object by one mouse-click. Then, either press the Delete key or executed "Edit/Delete". The object is removed from the document. In the object tree (fig. 5.18) each object can be hidden (cf. section 5.4.1.1).

How do I move an object on the current page?

Select it with the left mouse button, keep the button pressed and track the object to the desired position, release the button. The order of the objects (cf. section 5.4.1.1) is not changed.

How do I drag an object from the current page to another page?

Select the object, copy it to the Clipboard and switch to the new page. There you select the object, before which the copied object is to be inserted. Paste the object from the Clipboard. This changes the order of the objects (cf. section 5.4.1.1).

5.4.1.1 Document organization and the Explorer

The Print Designer administrates all OLE objects in a document as a linked list. On the worksheet the objects are displayed in the order of their accommodation into the list. The program automatically provides the necessary page breaks. The object order is important whenever objects are to be displayed next to each other or overlap. An object can only be covered by its successors in the list (cf. section 5.4.4).

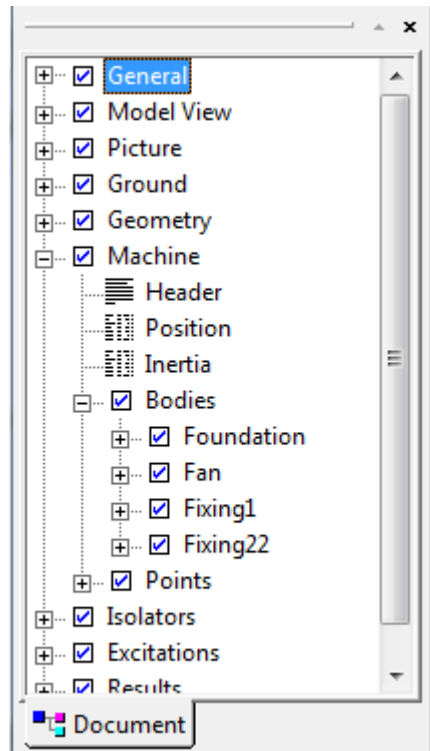

fig. 5.18 Explorer

The object list is generated by the program calling the Print Designer as a list with several hierarchic levels. It can be modified by the user by deleting or adding objects. New objects are either added before a selected object or at the end of the list. The Explorer (object view), shown in **fig. 5.18** shows the object list and its hierarchic levels for an example.

The handling of the tree agrees with to the Windows standard. Additionally the following possibility exists: By a click on a symbol in the Explorer the corresponding object can be hidden (symbol grey) or shown (symbol colored), without deleting it from the list. Complete branches can be hidden or shown by clicking the tag (✓).

5.4.2 Object types and their manipulation

ISOMAG puts the following object types into an output listing:

5.4.2.1 Graphics

Graphics, as for example the model view and result charts, are static objects. They cannot be edited.

5.4.2.2 Parameters

Parameter objects contain all input parameters of a model object (name, value, unit) in tabular form. They are a special kind of table objects. In the activated state (cf. section **5.4.4**) the following manipulation are possible:

- Changing the fonts of heading and text. Separate adjustments are possible. Using the instruction "Format/Font" the Windows standard dialog for the font selection is opened.
- The column width is adjustable. Move the mouse over a column separator (cursor transforms to \leftarrow) and drag it to the left or right (click, hold, drag, release).

5.4.2.3 Tables

Table objects contain project data, summaries, the parts list, etc. of a project. In the activated state (cf. section **5.4.4**) the following manipulations are possible:

- Changing the fonts of heading and text. Separate adjustments are possible. Using the instruction "Format/Font" the Windows standard dialog for the font selection is opened.
- The column width is adjustable. Move the mouse over a column separator (cursor transforms to \leftarrow) and drag it to the left or right (click, hold, drag, release).

5.4.2.4 Texts

Texts are for example headings and inserted text blocks. If activated (cf. **section 5.4.4**) the following manipulations are possible:

- Inserted text blocks can be modified. Any text input is possible.

- The character font is adjustable. Using the instruction "Format/Font" the Windows standard dialog for the font selection is opened.
- An alignment of the text (left, center, right) is possible. Using the instruction "Format/Alignment". This alignment is not to the same as the object adjustment (toolbar, cf. section 5.4.4)!

5.4.2.5 Others

Apart from the listing above the output log can contain objects of all registered OLE types (texts from Word, tables from Excel, bitmaps, flow charts, CAD drawings etc.). In the activated state the object is opened application environment and can be edited in place.

5.4.3 Object properties

Each object has a set of attributes. These attributes are preset by the generating program and can be modified only in the administrator mode (cf. section 5.4.5).

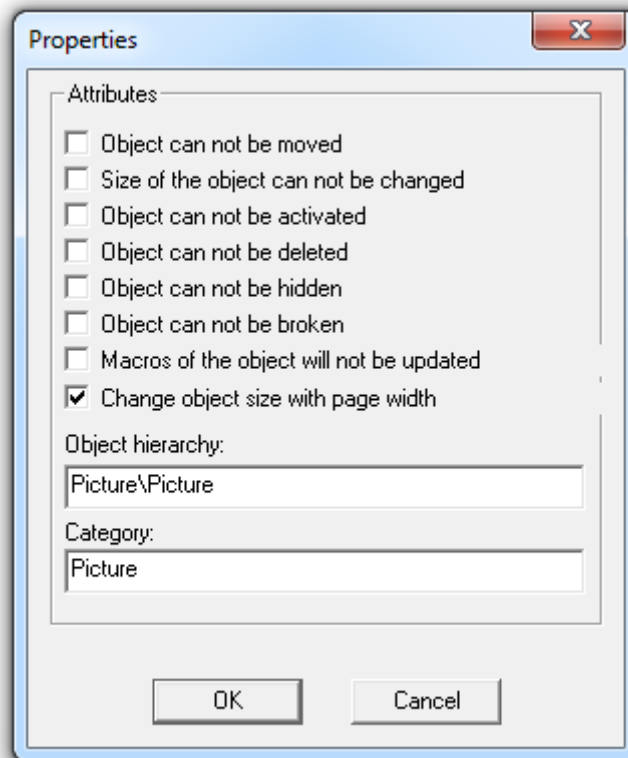

fig. 5.19 Object attributes

The dialog for editing the object characteristics is opened with the instruction "Edit/Properties... ". The attributes are self-explaining. Some additional comments:

Object cannot be broken: Text and table objects are normally adapted optimally to the page length and, if necessary a form feed is inserted. This property can be deactivated, in order to always display for example a table completely.

Macros belonging to the object are not updated: The Print Designer can handle macros, which are updated by the object generating program. Macros are preceded by an ampersand (&). If you switch this property off, the macros contained in the template are not assigned with the current values.

Change object size with page width: If this attribute is set, the object size is adapted automatically to the width of the page. If the page width ("File/Page Settings") changes, the object size will be updated.

5.4.4 Handling

The following section describes in detail the usage of the Print Designer as well as its specific instruction and buttons. The reader is expected to be familiar with the Windows typical actions (save, print, copy, paste, load etc.).

An object can be activated or selected. The selection or activation of the current object is cancelled by clicking outside of this object. Only one object can be selected or activated at a time. Thus a simultaneous handling of several objects is not possible.

Activated objects have a special menu, which corresponds to their origin. The possibilities to manipulate **selected objects** are explained in the following.

5.4.4.1 Moving objects

Move the cursor over the selected object, click it with the left mouse button, keep the button pressed and drag the object to the desired place. This allows moving an object within a page. If an object is to be placed on another page, one cuts it from the current position and inserts it at the new position. Dragging in vertical direction only changes the distance to the preceding object. The distance to the following object remains unchanged (**fig. 5.20**). So the page should be designed from top to bottom.

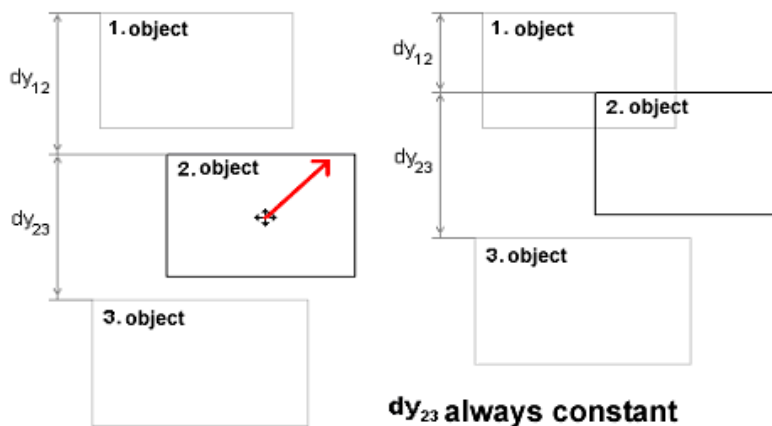

fig. 5.20 Moving of objects





5.4.4.2 Scaling objects

A selected object has 8 scaling markers. You can click a marker with the mouse and change the object size by moving the mouse into the desired direction. Release the

mouse button at the new position. If the proportions are to be preserved during the scaling, the Ctrl key has to be pressed during the mouse movement.

5.4.4.3 Browse and Zoom

Documents usually have several pages. The current page number and the page quantity are displayed in the status bar. The following functions are used for browsing and zooming:



-  First page: Move to the first page
-  Previous page: Move to the preceding page
-  Next page: Move to the next page
-  Last page: Move to the last page

 Scale: By means of this combobox a predefined scale factor can be selected for the page display. This adjustment does not refer to the actual printout.

 Zoom: With the magnifying glass function any area can be selected for display. For this one clicks on the magnifying glass in the Toolbar and draws a rectangle including the interesting area.

5.4.4.4 Select area





Editing always takes place in the current area only. I.e., if you want to edit an object in the heading, you must click the corresponding button in the Toolbar first.

-  Page: the page range is selected
-  Heading: the head area is selected
-  Footing: the foot area is selected

5.4.4.5 Format

Each object can be aligned horizontally using the corresponding button on the worksheet:

   left justified, centered, or right-justified alignment of the current object

     object receives a line at the edge shown on the button

Via a combobox you can select the color for the frame.

5.4.4.6 Others

 **Insert a Text object:** With this Button a user-defined text object before the selected object or at the end of the document is inserted. The object can be edited in accordance with 5.4.2.4.

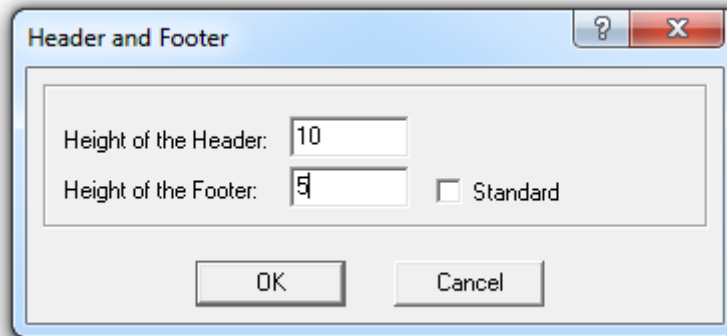

fig. 5.21 Dialog Header and Footer

Menu instruction "**Format/Header and Footer**": These adjustments are in particular important for the creation of new templates. The height of heading and footing is stored in the template. The adjustments can be defined to be the standard setting for newly created templates and documents. Choosing a standard setting does **not** affect existing templates and documents.

Menübefehl "**Format/Einstellungen...**":

- **Support divided views:** If this option is selected, up to four pages can be displayed at the same time. For adjustment click the page divider in the horizontal or vertical scrollbar and drag it to the desired position. A change in this option becomes only effective after a restart of the program.



- **Automatic distance adjustment (vertical):** This value refers to the vertical distance of individual objects, which are generated by the program. A modification of this value affects new documents only.

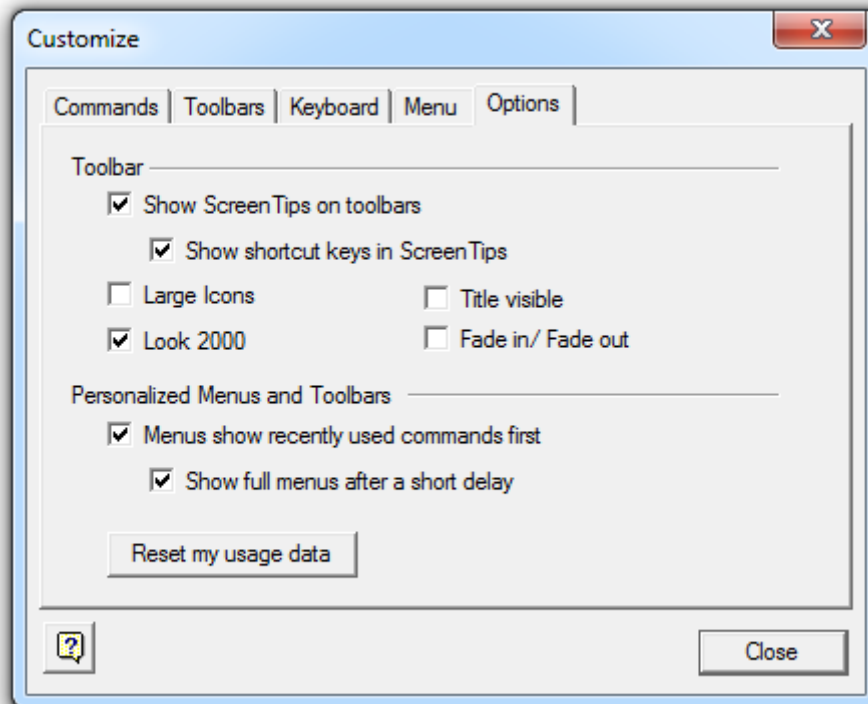

fig. 5.22 In "Extras" toolbars etc. can be modified

Additionally, with "**Extras/Customize**" you can change the appearance of menus and toolbars Microsoft Office products.

5.4.5 An individual template

ISOMAG uses **only one** pre-defined template. This template (ISOMAG.DDS) must be stored in the database directory (standard: "...\Isomag\Databases "). If you want to use another template, you must edit the file ISOMAG.DDS. For this you proceeded as follows:

1. *Create a backup copy of the original ISOMAG.DDS.*
2. Start the Print Designer in the administrator mode using the Windows instruction "Start/Run... ". Enter the following in the box "Open":

"C:\Program Files\Isomag\PrintDesigner.exe / a"

3. Click OK. The Print Designer is started as usual, but without a template.
4. Load the template ISOMAG.DDS with "File/Open". You can also create a new template using "File/New ".
5. Edit the template.

Save the modified template with "File/Save" or "Save as... " as ISOMAG.DDS in the database directory. The existing file must be overwritten. For emergencies you still have your backup.

6 Bibliography

- [1] Großmann, K.; Schreiber, U.; Uhlig, A.; Ilchner, M.: Optimale Schwingungsisolierung von Maschinen und Baugruppen in Gebäuden und Anlagen mittels problemorientierter anwenderfreundlicher Software. Schriftenreihe der Bundesanstalt für Arbeitsschutz und Arbeitsmedizin, Fb 769, Wirtschaftsverlag NW Verlag für neue Wissenschaft GmbH, Dortmund/Berlin 1997
- [2] Richtlinie VDI 2062: Schwingungsisolierung, Blatt 1: Begriffe und Methoden. VDI-Gesellschaft Konstruktion und Entwicklung, Fachbereich Schwingungstechnik, VDI-Verlag, Düsseldorf 1976
- [3] Richtlinie VDI 2056: Beurteilungsmaßstäbe für mechanische Schwingungen von Maschinen. VDI-Gesellschaft Konstruktion und Entwicklung, Fachbereich Schwingungstechnik, VDI-Verlag, Düsseldorf 1964
- [4] Richtlinie VDI 2057: Einwirkung mechanischer Schwingungen auf den Menschen, Blatt 1 und 2. VDI-Gesellschaft Konstruktion und Entwicklung, Fachbereich Schwingungstechnik, VDI-Verlag, Düsseldorf 1987
- [5] Jörn, Raoul; Lang, Georg: Schwingungsisolierung mittels Gummifederelementen. Fortschritt-Berichte VDI Zeitschrift, Reihe 11, Nr. 6, VDI-Verlag, Düsseldorf 1968
- [6] Kempe, Volker: Dynamische Berechnung von Blocksystemen. In: Leichtbauhandbuch Band 6/1: CAD-Software AUTRA-M8, Institut für ökonomische Verwendung von Werkstoffen, Dresden 1987
- [7] Holzweißig, Franz; Dresig, Hans: Lehrbuch der Maschinendynamik. Fachbuchverlag Leipzig-Köln, Leipzig 1992
- [8] Fronius, S.; Holzweißig, F. (Hrsg.): Taschenbuch Maschinenbau, Band 2. Verlag Technik, Berlin 1985
- [9] Beitz, W.; Küttner, K.-H. (Hrsg.): Dubbel Taschenbuch für den Maschinenbau. 18. Auflage, Springer-Verlag, Berlin Heidelberg New York 1995
- [10] Koch, Heinz: Beitrag zur Dynamik der Blockfundamente und zur Schwingungsberechnung von Systemen mit mehreren Freiheitsgraden. TU Dresden, Fakultät für Maschinenwesen, Dissertation, 1975
- [11] Großman, Knut: Ein Beitrag zur Modellfindung und -berechnung für die dynamische Analyse von Werkzeugmaschinen-Strukturen. TU Dresden, Fakultät für Maschinenwesen, Dissertation, 1974
- [12] Laschet, Andreas: Simulation von Antriebssystemen. Springer-Verlag, Berlin Heidelberg New York 1988

- [13] Großman, Knut: Dynamische Verhaltensanalyse von spanenden Werkzeugmaschinen. TU Dresden, Habilitation, 1991
- [14] Melzig-Thiel, R.; Kinne, J.; Seidel, E.: Vorschriften und Normen für mechanische Schwingungen von Maschinen und an Arbeitsplätzen. Bundesanstalt für Arbeitsschutz, Dortmund 1995
- [15] Deutsche Norm DIN 1311: Schwingungen, Teil 1: Schwingungsfähige Systeme - Begriffe, Einteilung. DIN Deutsches Institut für Normung, Entwurf, Berlin 1994
- [16] Deutsche Norm DIN 1311: Schwingungen, Teil 3: Lineare, zeitinvariante schwingungsfähige Systeme mit endlich vielen Freiheitsgraden. DIN Deutsches Institut für Normung, Entwurf, Berlin 1994
- [17] Deutsche Norm DIN 4024: Maschinenfundamente, Teil 2: Steife (starre) Stützkonstruktionen für Maschinen mit periodischer Erregung. DIN Deutsches Institut für Normung, Berlin 1988
- [18] Europäische Norm prEN 1299: Mechanische Schwingungen und Stöße - Schwingungsisolierung von Maschinen - Angaben für den Einsatz von Quellenisolierungen. Technisches Komitee CEN/TC 231, Entwurf, 1995
- [19] Firmenschrift: GERB Schwingungsisolierungen. GERB, Berlin, 9. Auflage 1992
- [20] Firmenschrift: PHOENIX METALLGUMMI.
- [21] Firmenschrift: Schwingungsisolierung. LBF INDUSTRIETECHNIK, Lauterbach
- [22] Firmenschrift: Standard-Bauelemente für die Schwingungsisolierung. Freudenberg-Megulastik, Weinheim
- [23] Firmenschrift: ContiTechnik Schwingmetall. Continental Gummi-Werke, Hannover 1987
- [24] [Gellert, W.; Küstner, H.; Hellwich, M.; Kästner, H. (Hrsg.): Kleine Enzyklopädie Mathematik. VEB Bibliographisches Institut, Leipzig, 9. gekürzte Auflage 1974
- [25] Bronstein, I. N.; Semendjajew, K. A.: Taschenbuch der Mathematik. BSB B. G. Teubner Verlagsgesellschaft, Leipzig und Verlag Nauka, Moskau 1979
- [26] Engeln-Müllges, G.; Reutter, F.: Numerik-Algorithmen: Entscheidungshilfe zur Auswahl und Nutzung. VDI-Verlag, Düsseldorf 1996
- [27] Werner, D.: Baudynamik. VEB Verlag für Bauwesen, Berlin 1989

- [28]** Korenev, B. G.; Rabinovič, I. M.: Baudynamik, Handbuch. VEB Verlag für Bauwesen, Berlin 1980
- [29]** Woo, M.; Neider, J.; Davis T.: OpenGL Programming Guide. Second Edition, Silicon Graphics, Inc., Addison-Wesley Developers Press 1997
- [30]** Bachmann, H.: Erdbebensicherung von Bauwerken. Birkhäuser Verlag, Basel, Boston, Berlin 1995

Figures

	Page	
fig. 1.1	Classification of the vibration isolation into the protection against vibration	12
fig. 2.1	Minimum models for the vibration isolation, one-mass oscillator a) force excitation for the vibration isolation of machines b) ground excitation for the vibration isolation of devices	15
fig. 2.2	The transmissibility as a function of frequency ratio and damping	18
fig. 2.3	Minimum models for the double vibration isolation, two-mass oscillator a) Force excitation for the vibration isolation of machines b) Ground excitation for the vibration isolation of devices	20
fig. 2.4	Natural frequencies of the bound two-mass oscillator, related to frequency and parameter of the one-mass oscillator	21
fig. 2.5	Transmissibility of the two-mass oscillator in comparison to the one-mass oscillator for deep tuning	23
fig. 2.6	η as function of the degree of isolation for the one and two-mass oscillator	24
fig. 2.7	Transmissibility of the two-mass oscillator in comparison to the one-mass oscillator for mixed tuning	25
fig. 2.8	Model of the flexibly mounted block foundation, with rigid coupling machine - foundation and 6 degrees of freedom	26
fig. 2.9	Flexibly mounted machine on flexibly mounted foundation, Model with 2 rigid bodies and 12 degrees of freedom	27
fig. 2.10	First vibration mode of a beam hinged on both ends	29
fig. 2.11	Beam clamped on both ends	31
fig. 2.12	Rectangular plate hinged on all sides	32
fig. 2.13	All-side clamped rectangular plate	34
fig. 2.14	Clamped and hinged rectangular plate	35
fig. 2.15	Flexibly mounted machine on flexibly mounted foundation with flexible installation place, model with 2 rigid bodies, one mass and 13 degrees of freedom	36
fig. 2.16	Distributed stiffness $c_z(x, y)$	37
fig. 3.1	Global coordinate system	42
fig. 3.2	Coordinate systems for machine and foundation	42
fig. 3.3	Center of gravity - coordinate system	43
fig. 3.4	Element coordinate system	43
fig. 3.5	Reference coordinate system	44
fig. 3.6	Buildup of the stiffness matrix for the dynamic calculation	54
fig. 3.7	ISOMAG database structure	68
fig. 4.1	Force / displacement curve with tangent at the operating point	72
fig. 4.2	The ISOMAG graphical user interface	75
fig. 4.3	Object hierarchy	76
fig. 4.4	Dialog window for duplicating objects	80
fig. 4.5	Units	81
fig. 4.6	Project settings	82
fig. 4.7	Basic settings	82
fig. 4.8	Object bar	84
fig. 4.9	Example for a label	85
fig. 4.10	General parameter dialog	86

fig. 4.11	Dialog for the position of a body	87
fig. 4.12	Dialog for the dimensions of a body	88
fig. 4.13	Menu for Undo/Redo	91
fig. 4.14	Parameter dialog for the description of the Inertia of bodies	92
fig. 4.15	The current inertia values of Block1	92
fig. 4.16	Complete inertia parameters	93
fig. 4.17	Definition of the cross section of a free prism	94
fig. 4.18	Information about an imported CAD-file	95
fig. 4.19	Listbox for the selection of the isolator type	97
fig. 4.20	Example of an isolator selected from the database	97
fig. 4.21	Parameter dialog for the stiffness of isolators	98
fig. 4.22	Parameter dialog for damping for the example of the isolator type "3D complete"	99
fig. 4.23	Dialog for limiting values for the example of the isolator type "3D complete"	100
fig. 4.24	Table with position and stiffnesses of the isolators	101
fig. 4.25	Dialog for the description of the environment	101
fig. 4.26	Dialog for the description of the excitation	103
fig. 4.27	Parameter dialog for the description of an imbalance excitation	105
fig. 4.28	Dialog Calculation Settings	106
fig. 4.29	Wizard for Single Vibration Isolation	108
fig. 4.30	Wizard for Double Vibration Isolation without an existing foundation	110
fig. 4.31	Wizard for double vibration isolation with already existing foundation (1)	111
fig. 4.32	Wizard for double vibration isolation with already existing foundation (2)	112
fig. 4.33	Result window for the principal moments of inertia	113
fig. 4.34	Result window for the display of the principal stiffness	114
fig. 4.35	Result dialog for static results of point	115
fig. 4.36	Result dialog for the natural frequencies and eigenvalues/vibration modes	116
fig. 4.37	Representation of dynamic results over the time	117
fig. 4.38	Representation of a displacement over the time	117
fig. 4.39	Representation of dynamic results over the frequency	118
fig. 4.40	Check for compliance with the required degree of isolation	119
fig. 4.41	Dialog for the adjustments of the animation	120
fig. 4.42	Video export settings. Left: Vibration shape, right: Natural mode shape.	122
fig. 5.1	Database connection for the selection of isolators	125
fig. 5.2	Rule for the analysis of the condition table	126
fig. 5.3	Input conditions	126
fig. 5.4	Staircase function	128
fig. 5.5	Linear interpolation	128
fig. 5.6	Spline interpolation	129
fig. 5.7	No special treatment	129
fig. 5.8	Reflection	130
fig. 5.9	Curve repetition	130
fig. 5.10	Result window overview	132
fig. 5.11	Dialog Properties, page "Window"	135
fig. 5.12	Dialog Properties, page Y Axes	136

fig. 5.13	Dialog Properties, page Graphics	137
fig. 5.14	Dialog Properties, page "Auxiliary Lines"	138
fig. 5.15	Result window with value display	140
fig. 5.16	Result window with activated measuring window	141
fig. 5.17	Example for an output listing	143
fig. 5.18	Explorer	144
fig. 5.19	Object attributes	146
fig. 5.20	Moving of objects	147
fig. 5.21	Dialog Header and Footer	149
fig. 5.22	In "Extras" toolbars etc. can be modified	150
fig. 7.1	Formation of the stiffness matrices, calculation of the static forces and dis-placements	161
fig. 7.2	Test on compliance with the static limiting values	162
fig. 7.3	Formation of the damping matrices	163
fig. 7.4	Program execution sequence, part 1	164
fig. 7.5	Program execution sequence, part 2	165
fig. 7.6	Program execution sequence: double vibration isolation, part 1	166
fig. 7.7	Program execution sequence: double vibration isolation, part 2	167
fig. 7.8	ISOMAG model of a vibration-isolated centrifuge	174
fig. 7.9	Parameter dialog for description of a block	175
fig. 7.10	Parameter dialog for the description of a cylinder	176
fig. 7.11	Principal moments of inertia of the machine	177
fig. 7.12	Wizard for simple vibration isolation	178
fig. 7.13	Search in the isolator database	179
fig. 7.14	Assignment of simultaneous positions	180
fig. 7.15	Some results of the revision calculation	181
fig. 7.16	Example Fan.isg	182
fig. 7.17	Results of the example Fan.isg	183
fig. 7.18	Example Fan2.isg	184
fig. 7.19	Fan2.isg: Transmissibility of displacement in z-direction of point A	185
fig. 7.20	Example Ground.isg	186
fig. 7.21	Results of the example Ground.isg	188

Tables

	Page	
Table 4.1	Outline of all ISOMAG model objects	77
Table 4.2	Objects, which supply results of the calculation	78
Table 4.3	Objects for additional information	78
Table 4.4	The table shows the behavior of the control elements during a synchronous parameter input for multiple objects	88
Table. 5.1	Keywords for labelling of curves	139
Table 7.1	Calculation of the inertia properties of the elementary bodies in element coordinates	168
Table 7.2	Menu instructions	169
Table 7.3	Buttons	172

7 Appendix

7.1 Syntax for alphanumeric inputs

7.1.1 Explanations concerning the notation

The rules for the formation of mathematical expressions are given in an extended Backus-Naur form. Each rule consists of the syntactic item (non-terminal) on the left hand side, the definition character, and a sequence of items (non-terminal, terminal ones, and special characters) on the right hand side. The following special characters are used:

<...>	non-terminal
::=	Definition character
{ ... }	Sequence of items, which can also be empty
[...]	optional inputs can be omitted
	alternative separator
cos	Terminal, characters which can be entered
A .. Z	Character from A to Z

During the interpretation of the rules the non-terminals on the right hand side are replaced by their definition. Terminals are to be entered as character strings. Upper and lower case have to be observed.

7.1.2 Mathematical expressions

<Expression>	::= <Product> { [+ -] <Product> }
<Product>	::= <Power> { [* /] <Power> }
<Power>	::= <SignFactor> [^ <SignFactor>]
<SignFactor>	::= [+ -] <Factor>

<Factor>	::= (<Expression>) <Function> (<Arguments>) <Number> <Variable identifier> e pi
<Function>	::= ln exp sinh cosh tanh sin cos tan sqrt abs int sign not arcsin arccos arctan arctan2 rad deg
<Argument>	::= <Expression> { , < Expression > }
<Variable identifier>	::= <Character> { <Character> <Digit> <Special Character> }
<Number>	::= <Digit> { <Digit> } [. <Digit> { <Ziffer> }] [e E [+ -] <Ziffer> { <Ziffer> }]
<Digit>	::= 0 .. 9
<Character>	::= A .. Z a .. z
<Special Character >	::= . _

7.1.3 Examples

12.9	Number
3+8	Expression
pi	3.14..., π

$3.0 \cdot 6^3$	Expression
$2.0 \cdot \sin(\pi/3)$	Expression
$6.8 \cdot \arctan2(0.8, -0.72)$	Function with two arguments

7.2 Figures

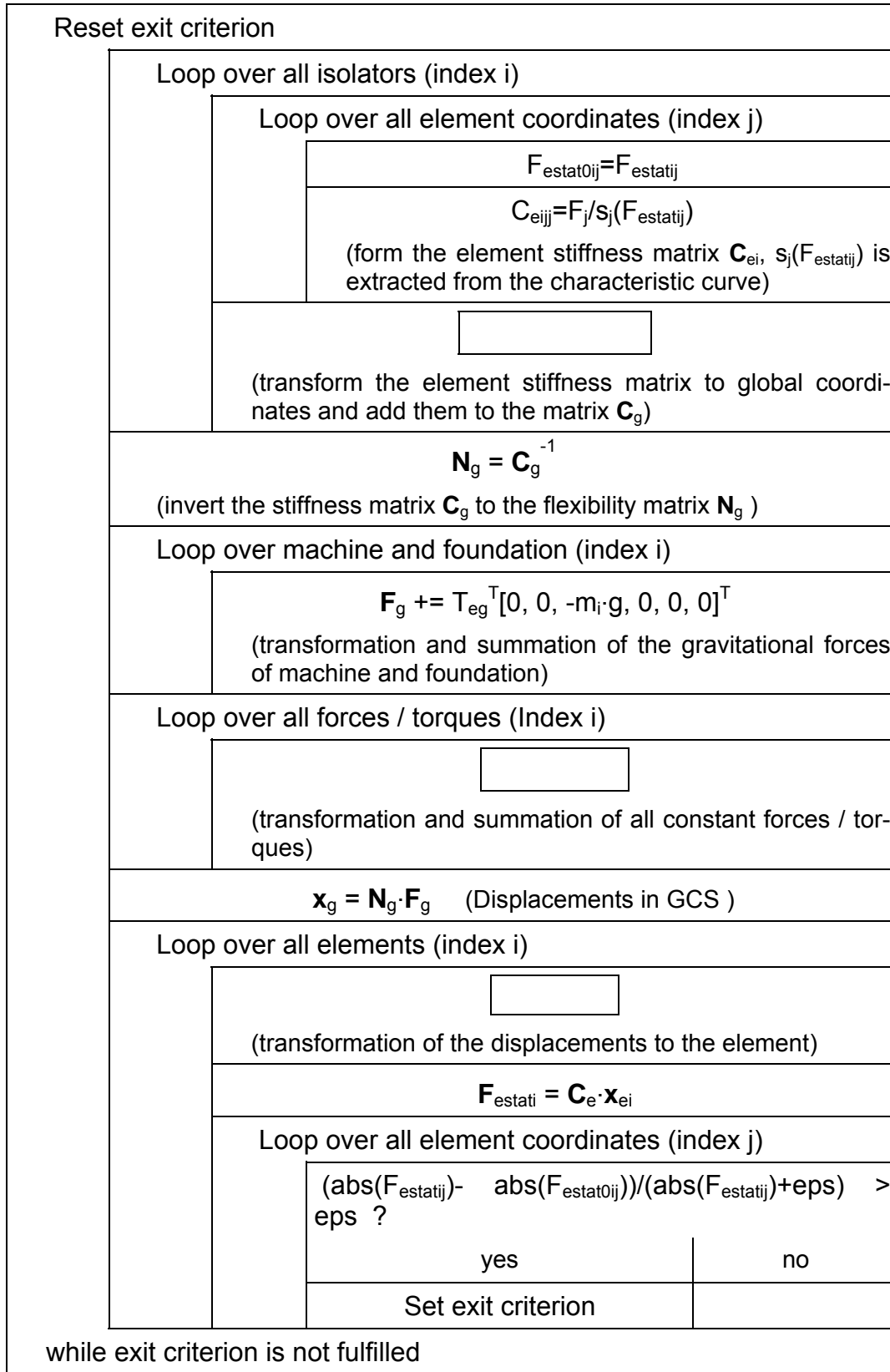

fig. 7.1 Formation of the stiffness matrices, calculation of the static forces and displacements

Loop over all isolators (index i)	
Loop over all coordinates of the isolator (index j)	
$F_{zulmin}(i,j) = 0$ and $F_{zulmax}(j) = 0$?	
yes	no
next j	
$-F_{estat}(i,j) < F_{zulmin}(i,j)$?	
yes	no
Message	
$-F_{estat}(i,j) > F_{zulmax}(i,j)$?	
yes	no
Message	
Loop over all coordinates of the element (index j)	
$s_{zulmin}(i,j) = 0$ and $s_{zulmax}(j) = 0$?	
yes	no
next j	
$-x_e(i,j) < s_{zulmin}(i,j)$?	
yes	no
Message	
$-x_e(i,j) > s_{zulmax}(i,j)$?	
yes	no
Message	

fig. 7.2 Test on compliance with the static limiting values

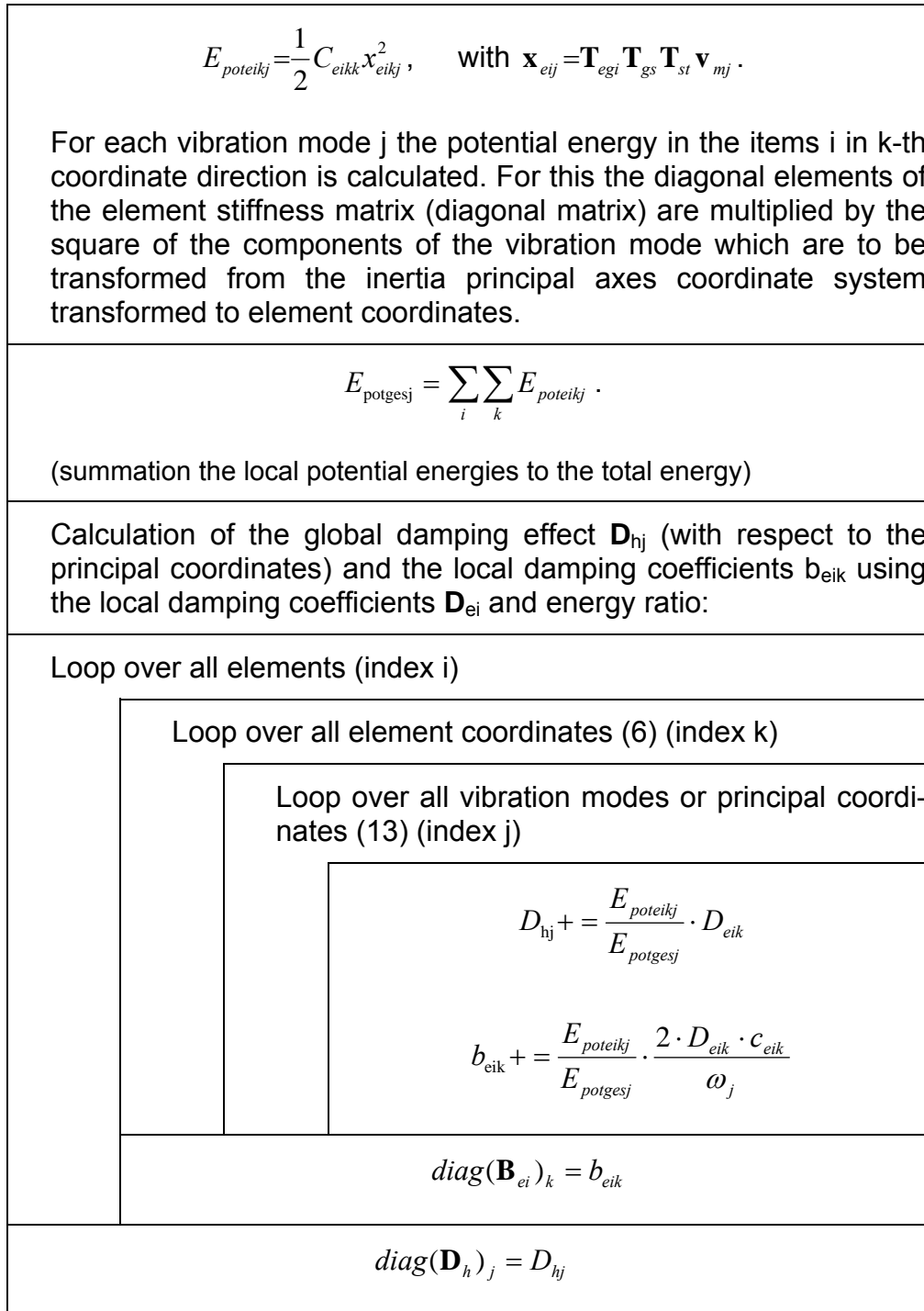

fig. 7.3 Formation of the damping matrices

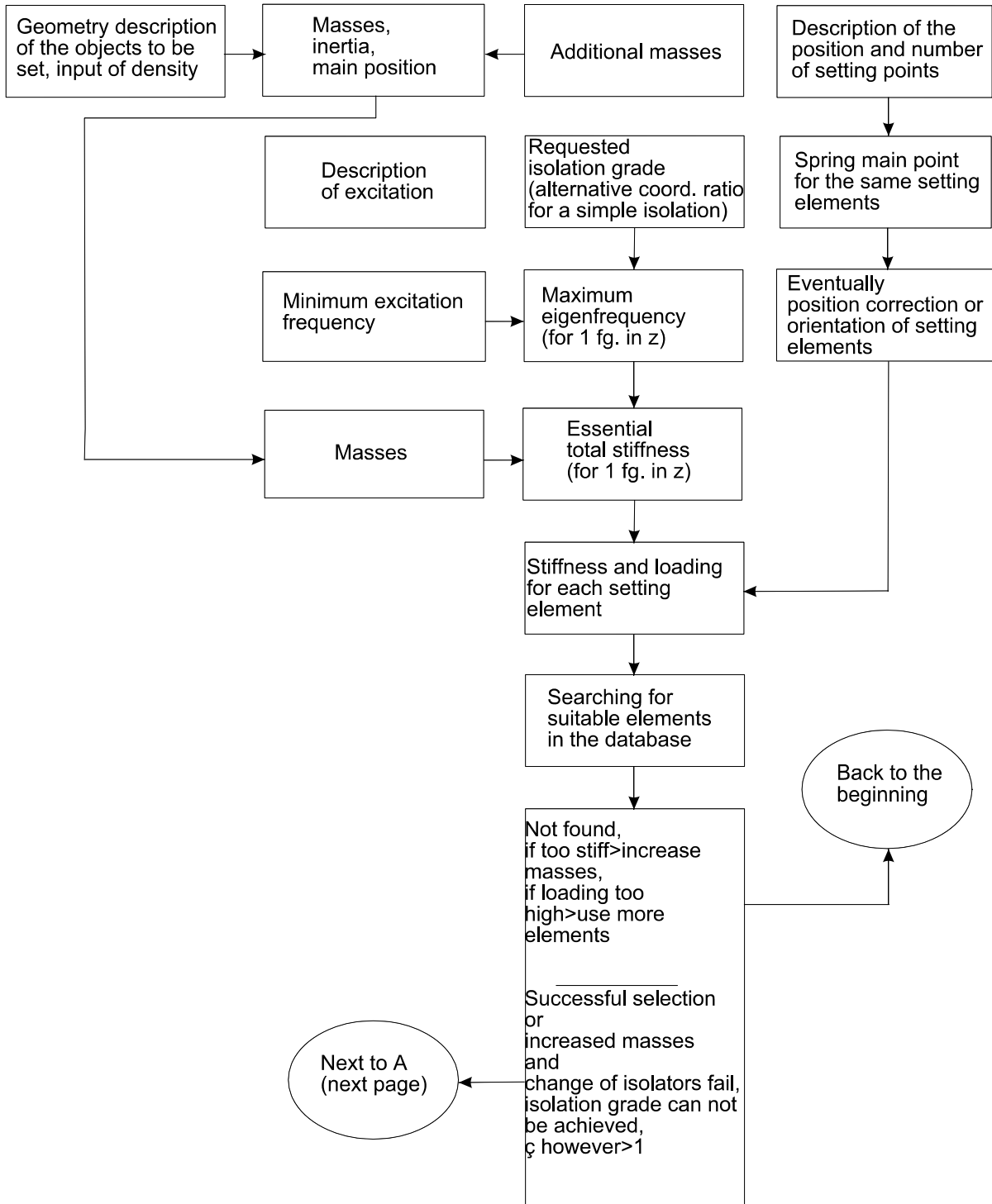

fig. 7.4 Program execution sequence, part 1

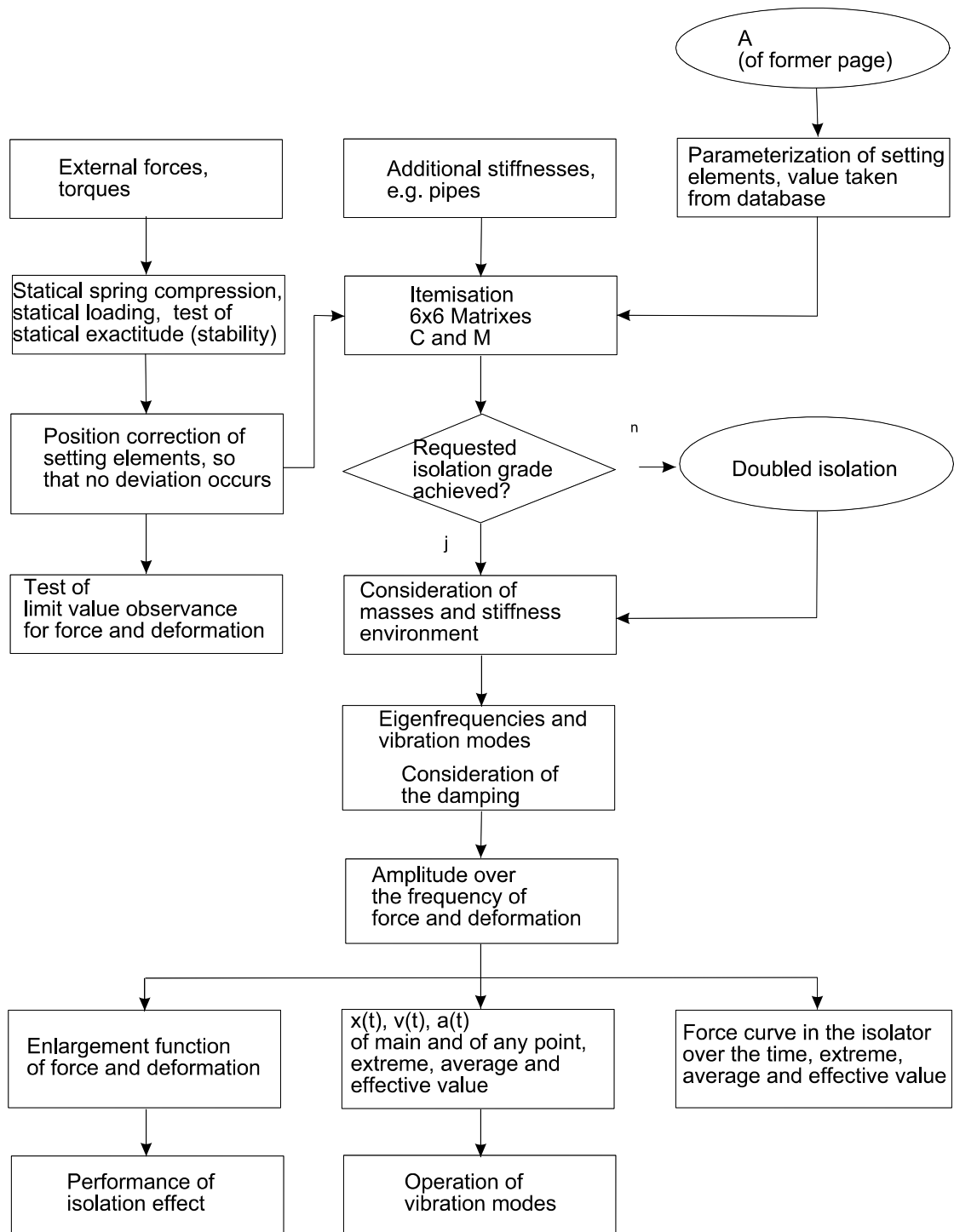

fig. 7.5 Program execution sequence, part 2

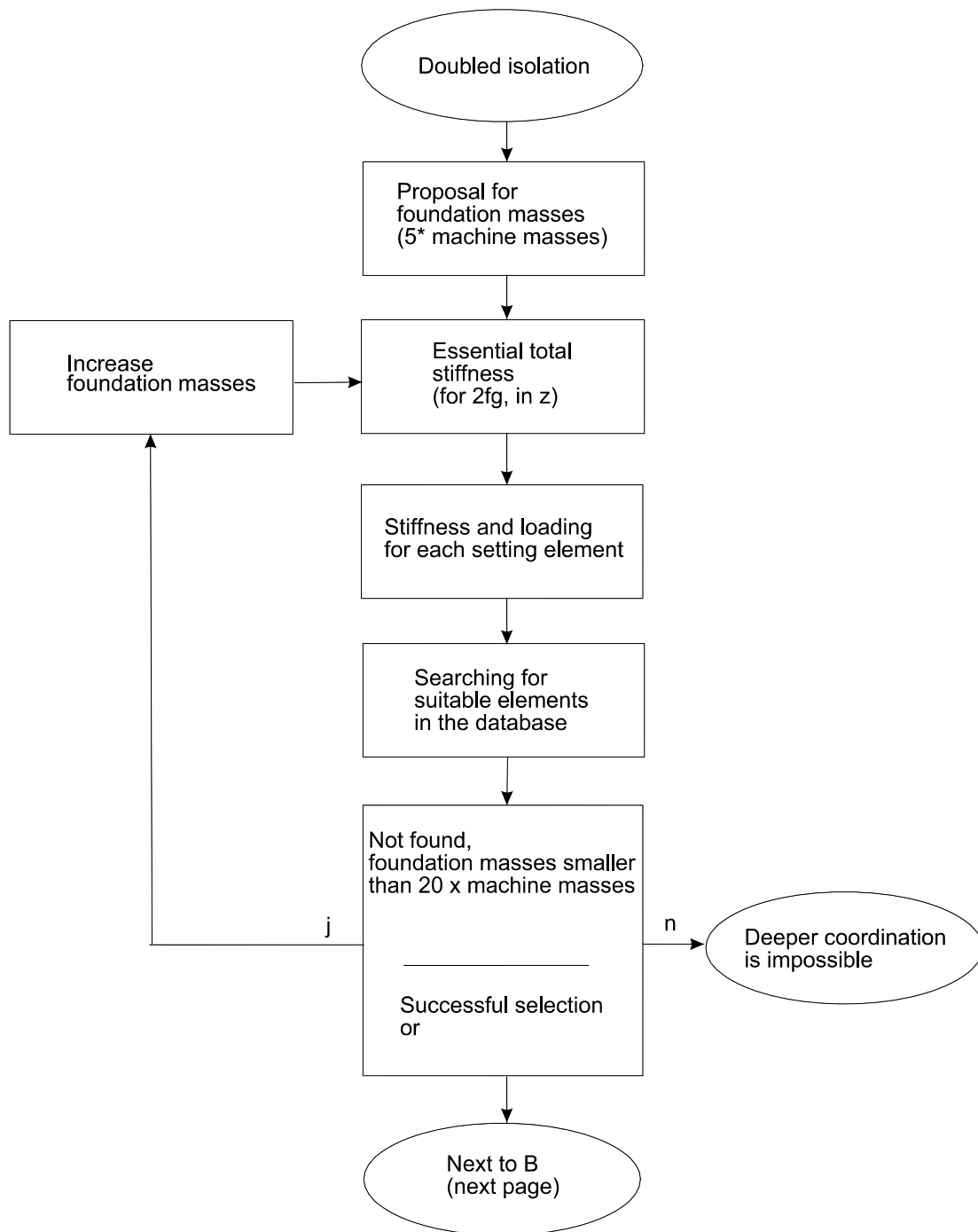

fig. 7.6 Program execution sequence: double vibration isolation, part 1

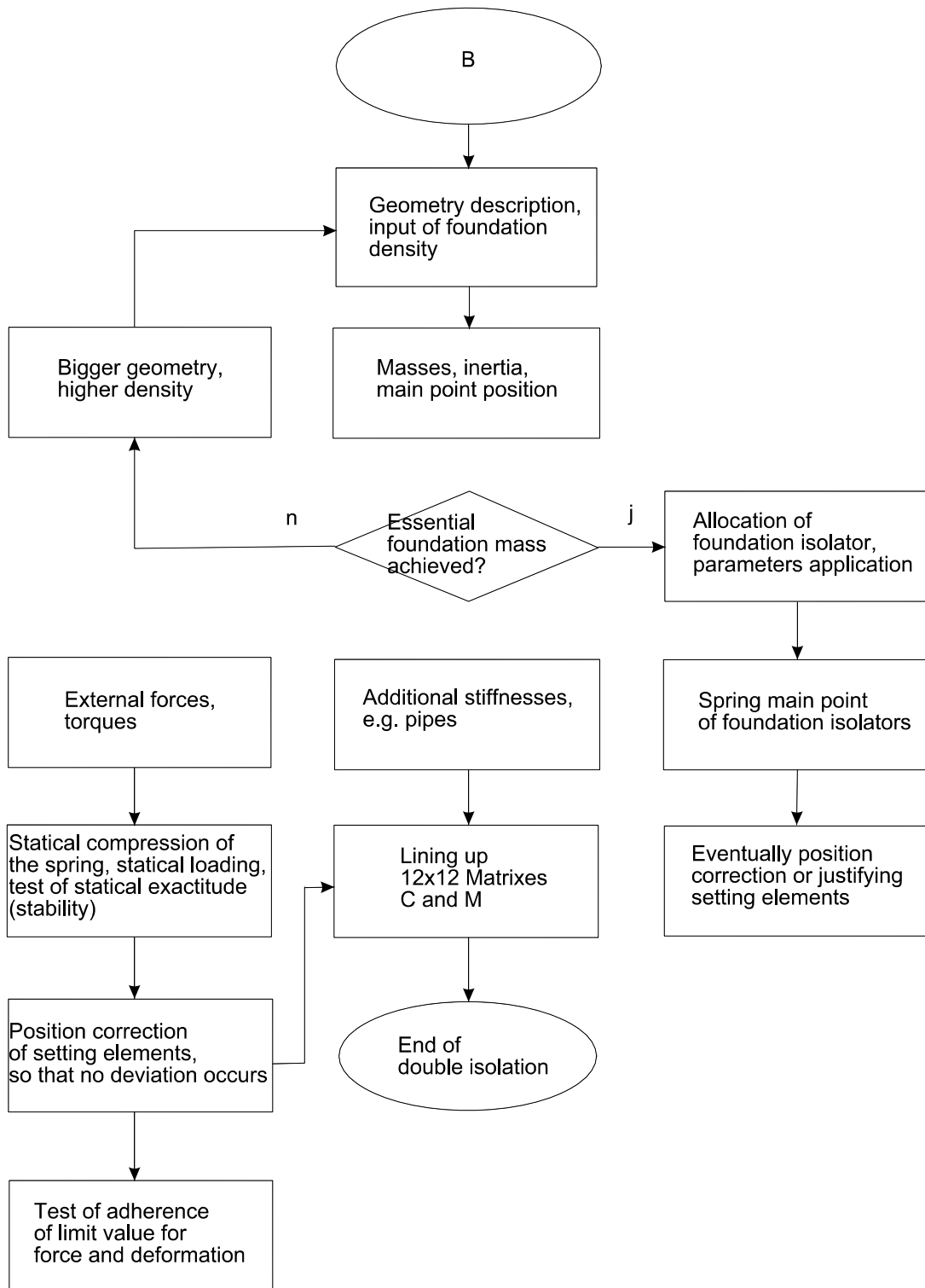
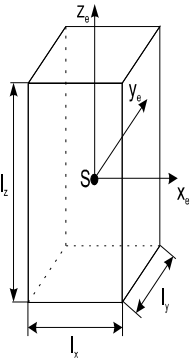
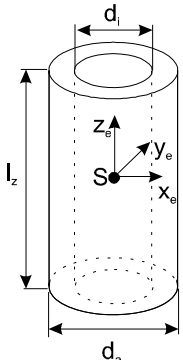
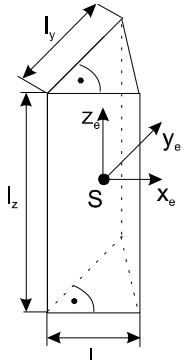
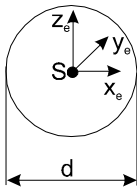

fig. 7.7 Program execution sequence: double vibration isolation, part 2

7.3 Tables

7.3.1 Inertia of the elementary bodies







Table 7.1 Calculation of the inertia properties of the elementary bodies in element coordinates



Body	Cuboid	Cylinder	Tree-edged-wedge	Ball
Sketch				
$m_e =$	$ff \cdot \rho \cdot l_x \cdot l_y \cdot l_z$	$ff \cdot \rho \cdot l_z \cdot \frac{\pi}{4} (d_a^2 - d_i^2)$	$\frac{1}{2} \cdot ff \cdot \rho \cdot l_x \cdot l_y \cdot l_z$	$\frac{1}{6} \cdot ff \cdot \rho \cdot d^3$
$J_{exx} =$	$\frac{m_e}{12} \cdot (l_y^2 + l_z^2)$	$\frac{m_e}{4} \cdot \left[\frac{l_z^2}{3} + \frac{1}{4} (d_a^2 + d_i^2) \right]$	$\frac{m_e}{6} \cdot \left(\frac{l_z^2}{2} + \frac{l_y^2}{3} \right)$	$\frac{1}{10} \cdot m_e \cdot d^2$
$J_{eyy} =$	$\frac{m_e}{12} \cdot (l_x^2 + l_z^2)$	$\frac{m_e}{4} \cdot \left[\frac{l_z^2}{3} + \frac{1}{4} (d_a^2 + d_i^2) \right]$	$\frac{m_e}{6} \cdot \left(\frac{l_z^2}{2} + \frac{l_x^2}{3} \right)$	$\frac{1}{10} \cdot m_e \cdot d^2$
$J_{ezz} =$	$\frac{m_e}{12} \cdot (l_y^2 + l_x^2)$	$\frac{m_e}{8} (d_a^2 + d_i^2)$	$\frac{m_e}{18} (l_x^2 + l_y^2)$	$\frac{1}{10} \cdot m_e \cdot d^2$
$J_{exy} = J_{eyx} =$	0	0	$\frac{m_e \cdot l_x \cdot l_y}{36}$	0

7.3.2 Menus



The program window contains the main menu. Following table explains the individual menu functions.

Table 7.2 Menu instructions

Menu instruction	Button	Action
"File"/ "New"	 Ctrl+N	Creates a new project.
"File"/ "Open"	 Ctrl+O	Opens a file.
" File"/ "Close"		Closes the current project.
"File"/ "Save"	 Ctrl+S	The current project is stored under its name. If no term was assigned, the Windows standard file dialog is opened ("Save as... ")
"File"/ "Save as..."		The Windows standard file dialog is opened. Select directory and file name, under which the current ISOMAG project is to be saved.
"File"/ "Print"	 Ctrl+P	This instruction starts the program "Print Designer" and generates the log printout in the background. Subsequently, the standard dialog "Print" is opened.
"File"/ "Page Preview"		This instruction starts the program "Print Designer" and generates the log printout.
"File"/ "Setup Printer"		Opens the standard dialog "Print Setup" of the Print Designer.
"File"/ "Exit"		The selection of this menu option terminates the program. The user is asked whether modified projects should be saved.
"Edit"/ "Cut"	 Ctrl+X	Selected objects are cut from the structure and copied to the Clipboard.
"Edit"/ "Copy"	 Ctrl+C	Selected objects are copied to the Clipboard.

Menu instruction	Button	Action
"Edit"/ "Paste"	 Ctrl+V	This instruction is only selectable if ISOMAG objects are stored in the Clipboard. From there the objects are inserted to the current project.
"Edit"/ "Delete"	Del	The selected objects are deleted. This instruction cannot be undone.
"Edit"/ "Properties..."	Enter	Opens the parameter dialog.
"Edit"/ "Duplicate..."	Ctrl+D	Opens the dialog for duplicating of selected objects.
"Edit"/ "Isolator Table"		Opens the isolator table.
"Edit"/ "Label"		Creates or deletes a label for the selected objects.
"Edit"/ "Copy View to Clipboard"		Creates a Bitmap of the 3D-View(s) and copies it to the clipboard.
"Calculation"/ "Settings..."		Opens the dialog with the calculation settings.
"Calculation"/ "Wizards"		Opens the respective wizard for the simple or double vibration isolation.
"Calculation"/ "Calculate automatically"		Switches the automatic recalculation on or off.
"Results"/ "Principal Inertia", "Principal Stiffness", "Natural Frequencies...", "Max. Load on Ground"		Opens the corresponding Result dialog.

Menu instruction	Button	Action
"Results"/ "Animation"		Starts the animation.

"View"/ "One View" "Four View"	 	Switches to the corresponding view mode.
"View"/ "Adjust"		Aligns the 2D-Views and executes "zoom all" for the 3D-View.
"View"/ "Status Bar"		Switches the Status Bar on or off .









"Extras"/ "Units..."		Opens the dialog for adjustment of the physical units.
"Extras"/ "Project Settings..."		Opens the parameter dialog for the project.
"Extras"/ "Settings..."		Opens the dialog with the basic settings of the program.
"Extras"/ "Isolator Defaults..."		Opens the dialog for changing the default values for new isolators.





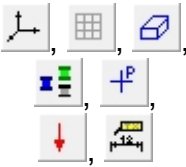









"Window"/ "New Window"		Opens a new project window.
"Windows"/ "Cascade"		This instruction arranges the project window in such a way that all title bars are visible.
"Window"/ "Tile Horizontally"		The instruction arranges the project window in such a way that all windows are completely visible.

7.3.3 Toolbar buttons

The following table explains buttons, which do not correspond to menu instructions:

Table 7.3 Buttons

Button	Action
	Select and move. In this pointer mode objects can be selected and dragged. Parameter dialogs can be opened. The "pressed" Button indicates this mode to be selected.
	Undo the last action.
	Redo the last undone action.
	Select and rotate. In this rotation mode objects can be selected and turned. The "pressed" Button indicates this mode to be selected.
	With the check box "Calculation of static Displacement" the calculation and animation of the static sagging can be suppressed. This is of interest, for instance, for systems with pneumatic springs and automatic height control.
	Enables or disables the selection of coordinate systems, ground, bodies, isolators, points, excitations, measurements and labels.
	Switches the visualization of the coordinate systems for main stiffness and main inertias on or off.
	If the Button "Parameter Dialog " is activated, the parameter dialog is opened automatically, if one puts a new object on the worksheet.
 or R	Switches into the mode "Rotate view".

 or X	Switches into the mode "Rotate view around X".
 or Y	Switches into the mode "Rotate view around Y".
 bzw. Z	Switches into the mode "Rotate view around Z".
 bzw. T	Switches into the mode " Move View".
	Switches into the mode "Zoom".
	Enlarges all views.
	Reduces all views.
	Zooms all views such that the complete model is displayed.
	Activates the front view in the 3D-View and does a "Zoom All". The button remains pressed until the next modification of the perspective.
	Activates the side view in the 3D-View and does a "Zoom All". The button remains pressed until the next modification of the perspective.
	Activates the top view in the 3D-View and does a "Zoom All". The button remains pressed until the next modification of the perspective.
	Activates a 3 dimensional view in the 3D-View and does a "Zoom All".
	Toggles between wire frame and solid display of objects.
	Toggles the 3D-View between perspective and parallel projection.

7.4 Examples

The following examples are supposed to be a guidance for an effective work with **ISOMAG** as well as for a training in the program usage. They are found in the directory ...\\ISOMAG\\Samples. In particular there are:

- Centrifuge.isg: Vibration isolation of a centrifuge showing the individual steps and dialogs
- Fan.isg: Vibration isolation of a fan, which is located on a flexible ground (steel plate)
- Fan2.isg: Like Fan.isg, but with double vibration isolation
- Ground.isg: A block foundation on ground. The ground is modeled as one spring.

7.4.1 Example Centrifuge.isg

The housing of the fan can be assumed to be composed of a cylinder and a mounting plate.

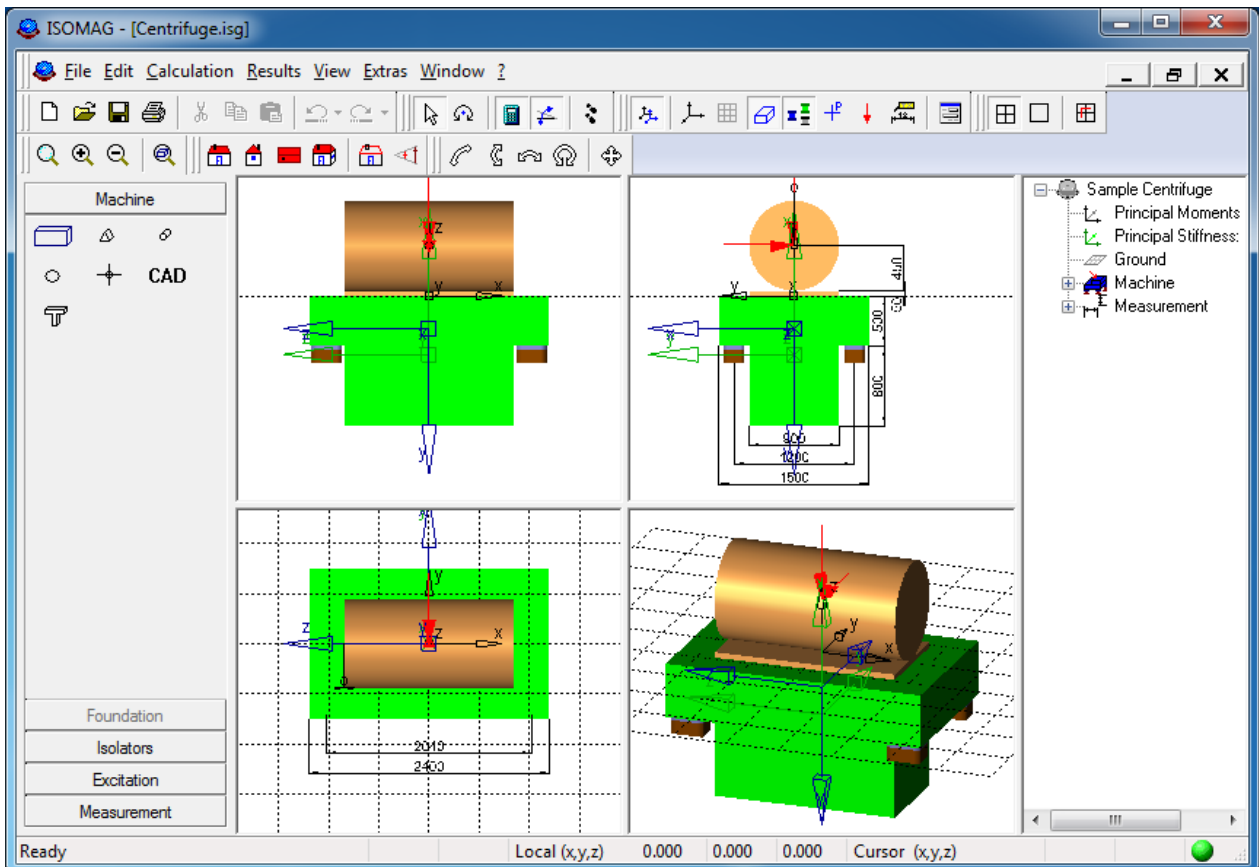

fig. 7.8 ISOMAG model of a vibration-isolated centrifuge

The cylinder has a diameter 900 mm and a length 1700 mm. The plate has the dimensions 1700x900x50 mm (in **fig. 7.8** displayed in a brighter color). The centrifuge

including the mounting plate has a mass of 1920 kg. It rotates with a speed of 1440 rpm. This causes a centrifugal force of 10 kN.

The vibration isolation has to ensure that the total of the forces transferred to the base is less than 200 N. Additionally, the vertical amplitude of the mass center of the oscillation-isolated object during operation must not exceed 0,05 mm.

First the geometry and the inertia of the centrifuge are described in ISOMAG. It is recommended to start with the mounting plate. Its geometry and material are entered in a parameter dialog (**fig. 7.9**).

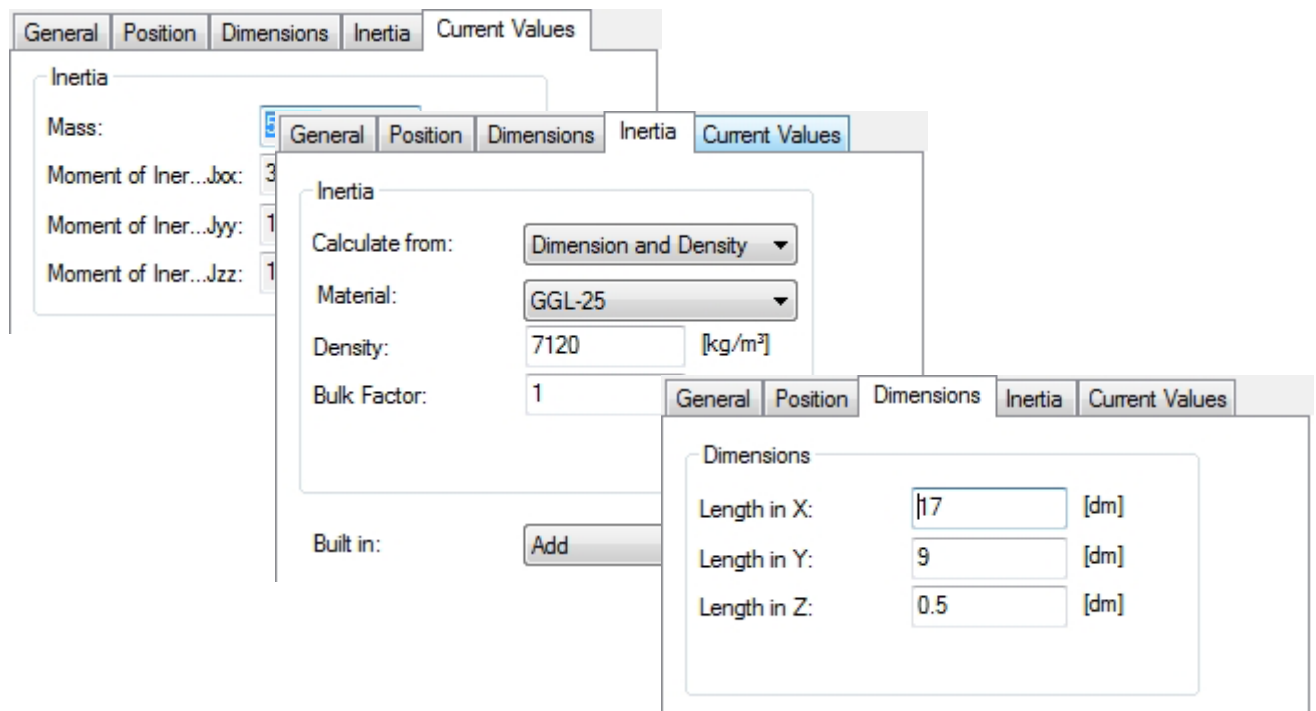

fig. 7.9 Parameter dialog for description of a block

The mass of the mounting plate determined by the program is about 545 (**fig. 7.9**). Consequently the mass of the cylindrical part is 1375 kg, the inertia properties are calculated from mass and dimensions. **fig. 7.10** shows the parameter dialog of a cylinder.

Note that ISOMAG can calculate the inertia properties of the bodies from different specifications (e.g. either from geometry and indication of material (**fig. 7.9**)). The centrifugal force is a circulating force vector. One can model it using the model object "Imbalance" or with two harmonic excitations displaced, where one is rotated by 90° relative to the other. The forces act at right angles onto the longitudinal axis of the cylinder (centrifuge's axis of rotation) (filled arrows in **fig. 7.8**).

fig. 7.10 Parameter dialog for the description of a cylinder

One now could start with the design of the vibration isolation and vary stiffness and mass ratios until the given limit values are observed. The goal is reached quicker, if one cares first about the adherence of the vibration displacement amplitude. This limit value can only be achieved by a sufficiently large mass of the object. This can be explained from the motion equation of the force-excited harmonic one-mass oscillator.

$$m\ddot{x} + b\dot{x} + cx = \hat{F} \cdot \sin(\Omega t) \quad (7.1)$$

Since the oscillator in the stationary state oscillates with the excitation frequency & one can describe the displacement x by (7.2) and use the expression to x in (7.1) (e.g. in [2]). The substitution leads (7.3).

$$x = \hat{x} \cdot \sin(\Omega t) \quad (7.2)$$

$$-m \cdot \hat{x} \cdot \Omega^2 \cdot \sin(\Omega t) + b \cdot \hat{x} \cdot \Omega \cdot \cos(\Omega t) + c \cdot \hat{x} \cdot \sin(\Omega t) = \hat{F} \cdot \sin(\Omega t) \quad (7.3)$$

The aim of the vibration isolation is it to keep the forces on the base small (in the given example they should not exceed. 2 % of the excitation force F cf. (7.8). Since the same forces act in the springs, the spring forces are neglectable compared to the excitation forces. Also the damping forces can be neglected here, as far as they concern material dampings and no special damping element are used. This simplifies (7.3) to

$$-m \cdot \hat{x} \cdot \Omega^2 \cdot \sin(\Omega t) = \hat{F} \cdot \sin(\Omega t) \quad (7.4)$$

From (7.4) it is evident that for a given excitation amplitude \hat{F} the vibration displacement amplitudes \hat{x} depend only on the mass m . The rearrangement of (7.4) gives:

$$m_{\min} = \frac{\hat{F}}{\Omega^2 \cdot \hat{x}} \quad (7.5)$$

In the example one calculates a minimum of 8800 kg results (7.6) :

$$8800 \text{ kg} = \frac{10000 \text{ kgm} \cdot 60^2 \text{ s}^2}{(1440 \cdot 2 \cdot \pi)^2 \cdot 0.00005 \text{ ms}^2} \quad (7.6)$$

Since the compressor is not heavy enough, one introduces additional masses (concrete foundation). These are shown in a darker color in **fig. 7.8**. In the result window "Principal Moments of Inertia" one can monitor the effect **fig. 7.11**

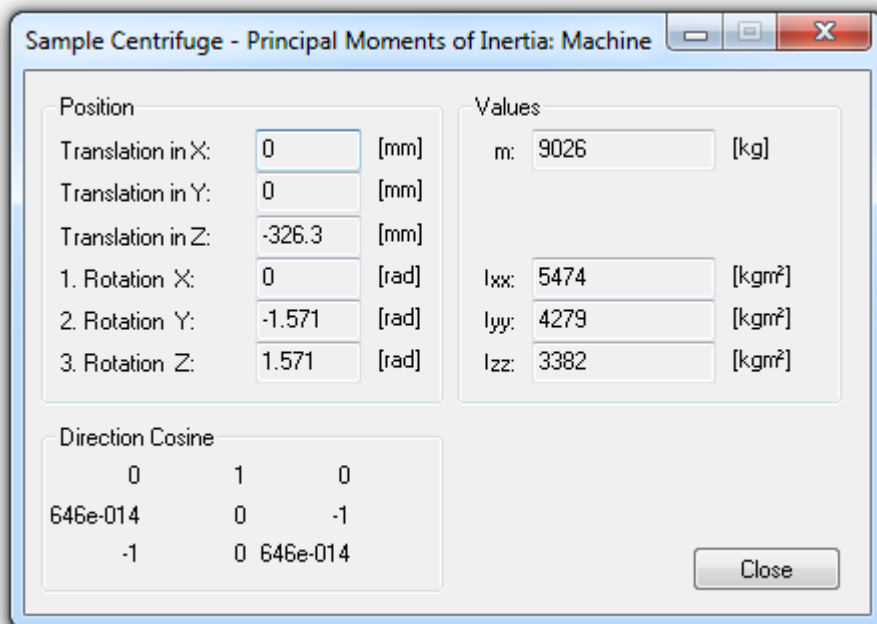

fig. 7.11 Principal moments of inertia of the machine

If the necessary mass is reached, the desired number of isolators (in **fig. 7.8** 4 pieces) is placed at suitable positions. Before this the automatic calculation should be switched off, in order to avoid unnecessary waiting periods. In order to ensure a horizontal alignment of the machine during the arrangement of the isolators, attention should be paid to the coincidence of the center of elasticity of the isolators and the center of gravity of the machine (i.e. that the vertical axis of the principal stiffness coincides with the vertical axis of the principal moments of inertia).

In order to achieve the vibration-isolating effect, the isolators must not exceed a certain stiffness value. Additionally they must bear the occurring loads. A wizard helps with the selection of suitable isolators (**fig. 7.12**). The wizard considers all data from the model which is known and relevant for the dimensioning. The data can be overwritten if necessary. In the example the required degree of isolation i is 98 %. In accordance with its definition (7.7) from the given excitation force amplitude and the admissible force \hat{F}_B on the base (7.8)

$$i = 1 - \frac{\hat{F}_B}{\hat{F}} \quad (7.7)$$

$$i = 1 - \frac{200N}{10000N} \quad (7.8)$$

The image shows a two-paneled wizard interface. The left pane, titled "Configuration", contains the following settings:

- Select the isolators to be considered!**
 - Selected isolators
 - All isolators
 - Input number (the model wont be changed!)
- Number of Isolators:** 4 [-]
- Criterion:**
 - Degree of Isolation 98 [%]
 - Tuning Ratio
- Check and edit the given values!**
 - Min. Excitation Frequ...** 24 [Hz]
 - Mass:** 9026.08 [kg]

Buttons at the bottom: Back, Next, C...

The right pane, titled "Selection", contains the following settings:

- Check the criterias for selection from database!**
 - Required Stiffness:** 0.0010061233569 [kN/μm]
 - Loading of one Isolator:** 0.0221364612
- Start database selection!**
 -
- The selected type will be assigned to the isolators after finishing of the wizard.**
 - P80/4213
 - Stahlfederisolator
 - cfm Schiller GmbH

Buttons at the bottom: Back, Finish, Cancel

fig. 7.12 Wizard for simple vibration isolation

Artikel_Nr	Typ	Firma	cAusl	Achse	Fmax	Fmin	Cx	Cy	Cz
P80/4213	spring is	cfm Scl	0,676	z	27,975	16,785	0,352	0,352	0,676
V 550	U	IT-Isolie	0,9615	z	22,5	10	0,6745	0,6745	0,9615
w 550	U	IT-Isolie	0,6452	z	26	12	0,4762	0,4762	0,6452
w 750	U	IT-Isolie	0,9033	z	36	17,5	0,6667	0,6667	0,9033
FS330-11	Air sprir	ContiTe	0,46	z	23,3	18,7	0,28	0,28	0,46
FS530-11	Air sprir	ContiTe	0,44	z	23,2	16,6	0,395	0,395	0,44
FS530-11	Air sprir	ContiTe	0,543	z	29,715	21,57	0,427	0,427	0,543
FD330-22	Air sprir	ContiTe	0,25	z	22,5	17,5	0,06	0,06	0,25
FD530-22	Air sprir	ContiTe	0,29	z	23,9	18,1	0,13	0,13	0,29

118 Records

Cancel Search >> Help OK

fig. 7.13 Search in the isolator database

From the input data the wizard calculates the required stiffness and the load the isolators can bear. With these values (and further selection criteria if necessary) one can look for suitable isolators in a database (**fig. 7.13**, see also section 5.1). With the values of the selected isolator type the model is parameterized in the sequel.

Since now the isolators are selected, the final alignment can take place. After placement of Isolator1 the others have to be aligned with respect to it. For this in each case two isolators have to be selected and in the parameter dialog (opened by context menu) the common positions have to be entered (**fig. 7.14**).

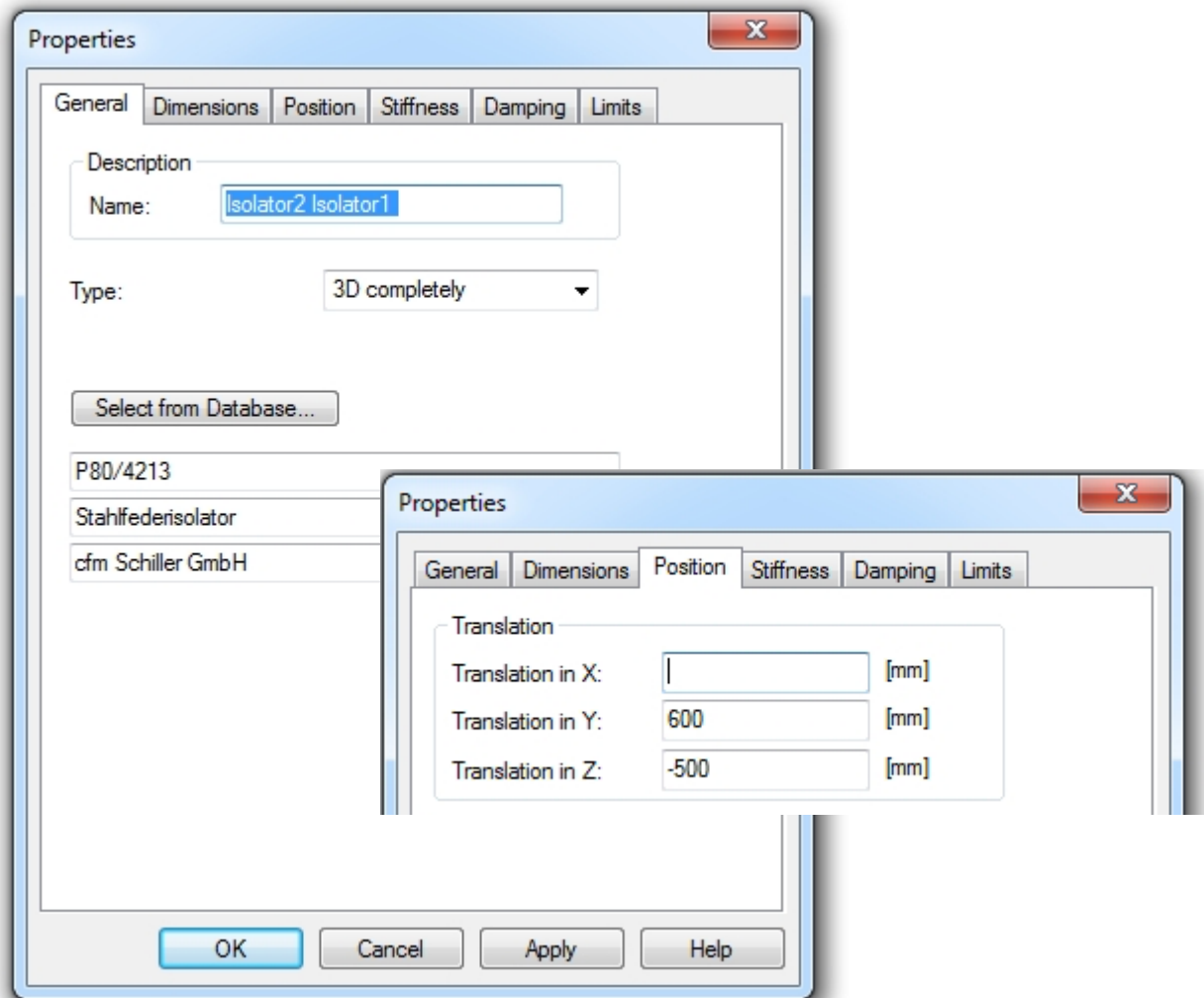

fig. 7.14 Assignment of simultaneous positions

Since the dimensioning for the one-mass oscillator takes place in vertical direction, there is a possibility that increased amplitudes occur through resonance in other vibration modes. It must be checked in the results of the revision calculation (**fig. 7.15**), whether the given limit values for base force and vertical displacements are also achieved in the complete system.

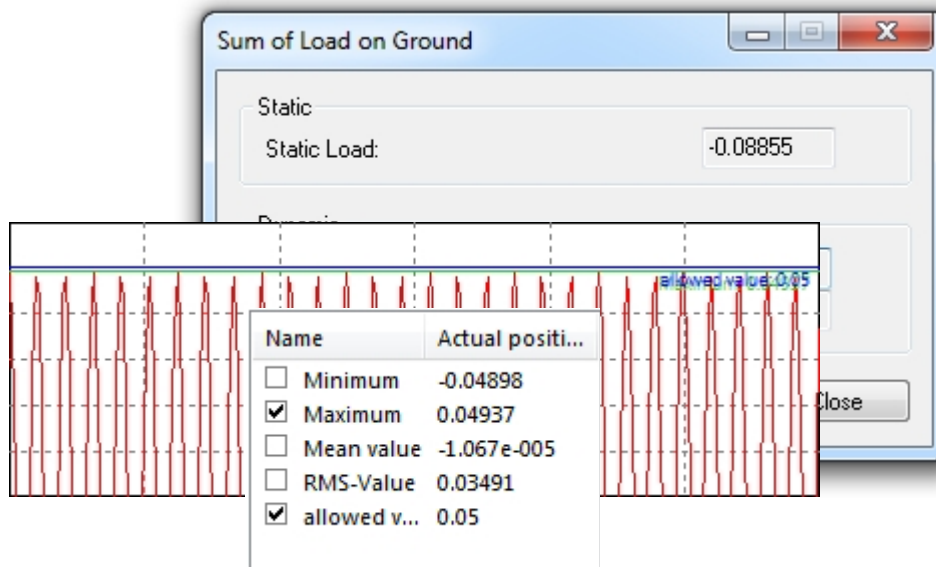

fig. 7.15 Some results of the revision calculation

One receives the "Time solution Principal Moments of Inertia..." in the above picture via the context menu of Machine - Principal Moments of Inertia. The setting of the diagram properties (axes, lines) is explained in detail in section 5.3.

Modifications of the model are possible at any time. Thus the system properties can be improved directly or parameter studies can be performed.

7.4.2 Example Fan.isg

A fan (speed: 5 Hz) standing off center on a concrete foundation with the dimensions 0.68 x 0.4 x 0.16 m³ (mass: approx. 100 kg) is to be installed in a vibration isolated manner. The imbalance excitation is replaced by a vertical force of 10 N. The dynamic load of the base plate must not exceed one third of the imbalance force of the rotor. The RMS of the vertical acceleration during operation must not be larger than 0.2 m/s².

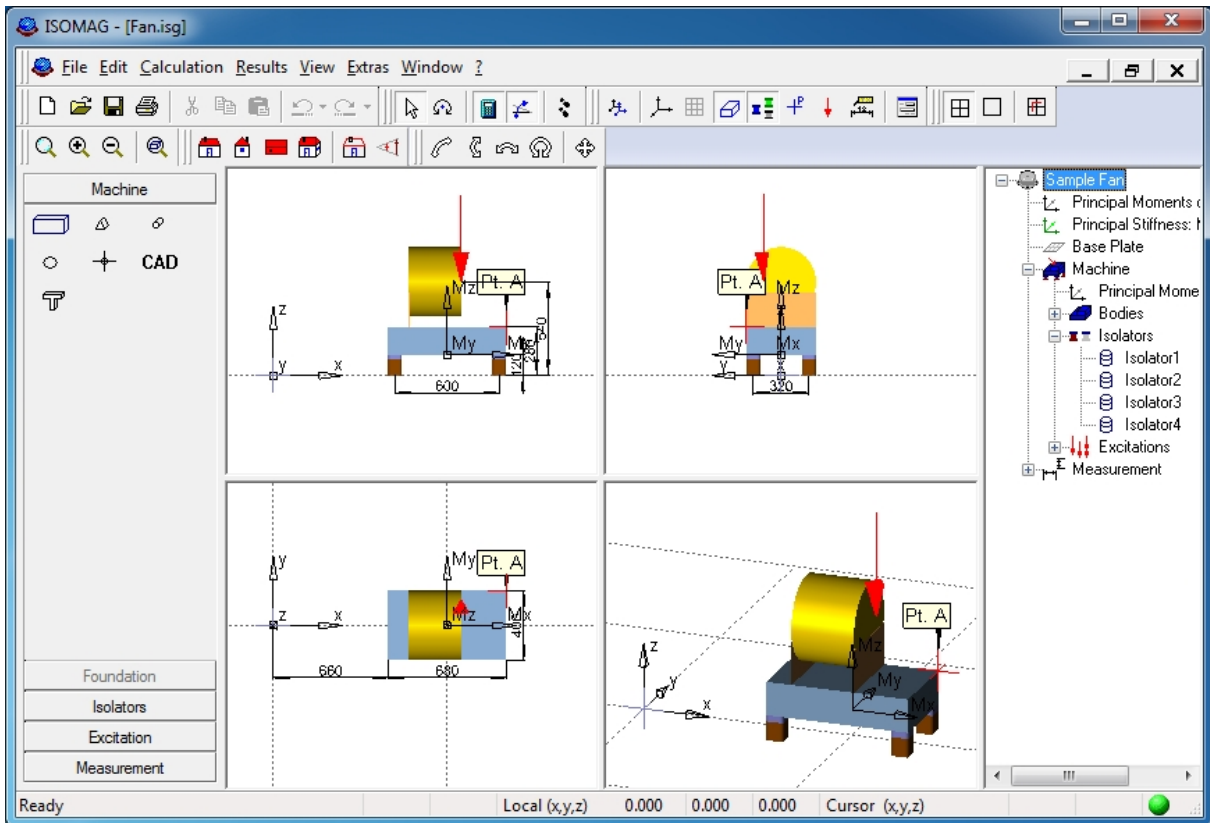

fig. 7.16 Example Fan.isg

First the components of the machine, the excitation and the base plate (ground) are modeled. The position information of the machine components refers to the coordinate system of the machine (in the example: geometrical center of the bottom surface foundation), i.e. the translation of the machine relative to the ground is not considered yet. In same way the point A which is necessary for the examination of the vertical acceleration, is defined. The off-center location of the machine is achieved by a translation of the coordinate system of the machine (in the project tree: Machine – Properties – Position). This methodology (using the coordinate system of machine), is of benefit if the positions of the machine parts are known relative to the machine, the position of the machine relative to the ground is still uncertain. The whole machine is translated by a translation of the coordinate system of the machine; the coordinates of the components (body, isolators, excitations, points) are thereby not modified since they are defined relative to coordinate system of the machine. Under normal conditions the global and the coordinate system of the machine are identical (see also section 3.1.1).

Subsequently four isolators are placed at the foundation corners. Since the dimensions of the isolators are not finally fixed yet, an exact adjustment is not necessary. After starting the wizard for simple vibration isolation the desired degree of isolation (67 %) or a tuning ratio 2 in the example are given. Excitation frequency and mass are extracted automatically from the model. The database search provides several isolators, with which the desired isolation can be achieved. In the example the isolator VL8/42 was selected, since it has the smallest stiffness in z-direction. With a larger quantity of isolators the softest isolator can be moved to the topmost

position in the column, by one click on the column heading 'c_{Ausl}' (corresponds to sorting by c_{Ausl}).

The check of the z-acceleration of the point A is performed using the time solution of the acceleration in z-direction (select the point A, open the context menu Results Dynamic/Time Solution/Acceleration/in z). The RMS is shown as an auxiliary line. Obviously the maximum admissible value is not reached (see **fig. 7.17**).

Time Solution

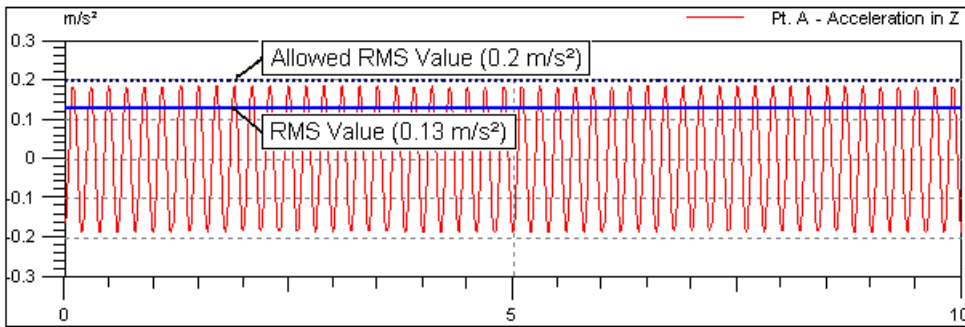

Transmissibility

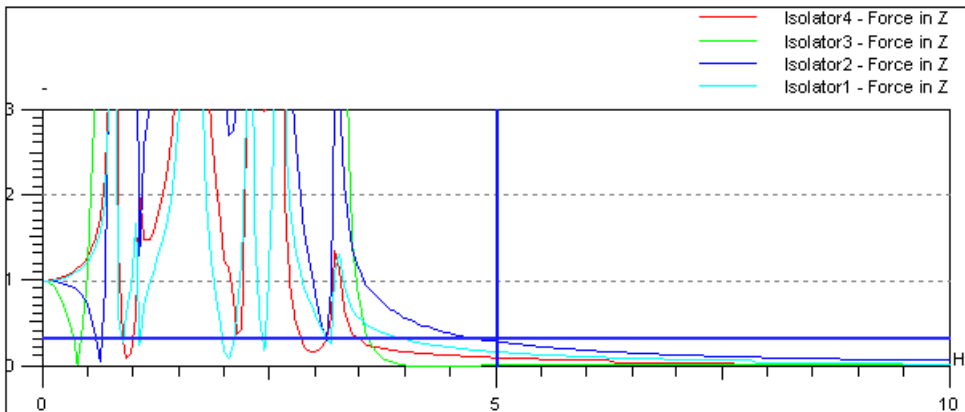

fig. 7.17 Results of the example Fan.isg

Now that the dimensions of the isolators are fixed, they can be placed accurately at the corners of the foundation by dragging them with the mouse. In order to lift the machine in such a way that the isolators are standing on the steel plate, as above a modification of the coordinate system of the machine (z-coordinate = height of the isolators) is made. The check of the compliance with the transmissibility takes place either via the display of the total floor load (in the project tree: Base plate – Total Load on Ground/ Maximum) or via the time solutions of the "correct according to phase or absolute value" sums of the ground loads in comparison to the excitation force of 10 N. Likewise using the transmissibilities of the load at all isolators (select all isolators –context menu: Results/Dynamic/Transmissibility/Load/in z) one obtains a well arranged diagram for the report to be printed (see **fig. 7.17**).

After entering additional information into the description of the project (Extra –Project Settings...) the model can be provided with measures. In order to be able to measure

the translation of the machine relative to the center of the plate, one point in the center of the base plate is created, to which the measure of 660 can be attached. Now the modeling and dimensioning are finished. With File –Page Preview the Print Designer can be started for printouts of the documentation. Only those result windows which are opened at the start of the Print Designer will be appear in the document. Thus an appropriate selection of the results can be done by the user. Additional labeling of the result diagrams as in **fig. 7.17** can be made either directly in the Print Designer by means of the text button or via the Menu /Edit – insert new object (e.g. MS-Word graphic). Also the graphic which is to be modified can be copied from the Print Designer to any graphics application (e.g. MS PowerPoint), completed there, and returned to the Print Designer or any other Windows program.

7.4.3 Example Fan2.isg

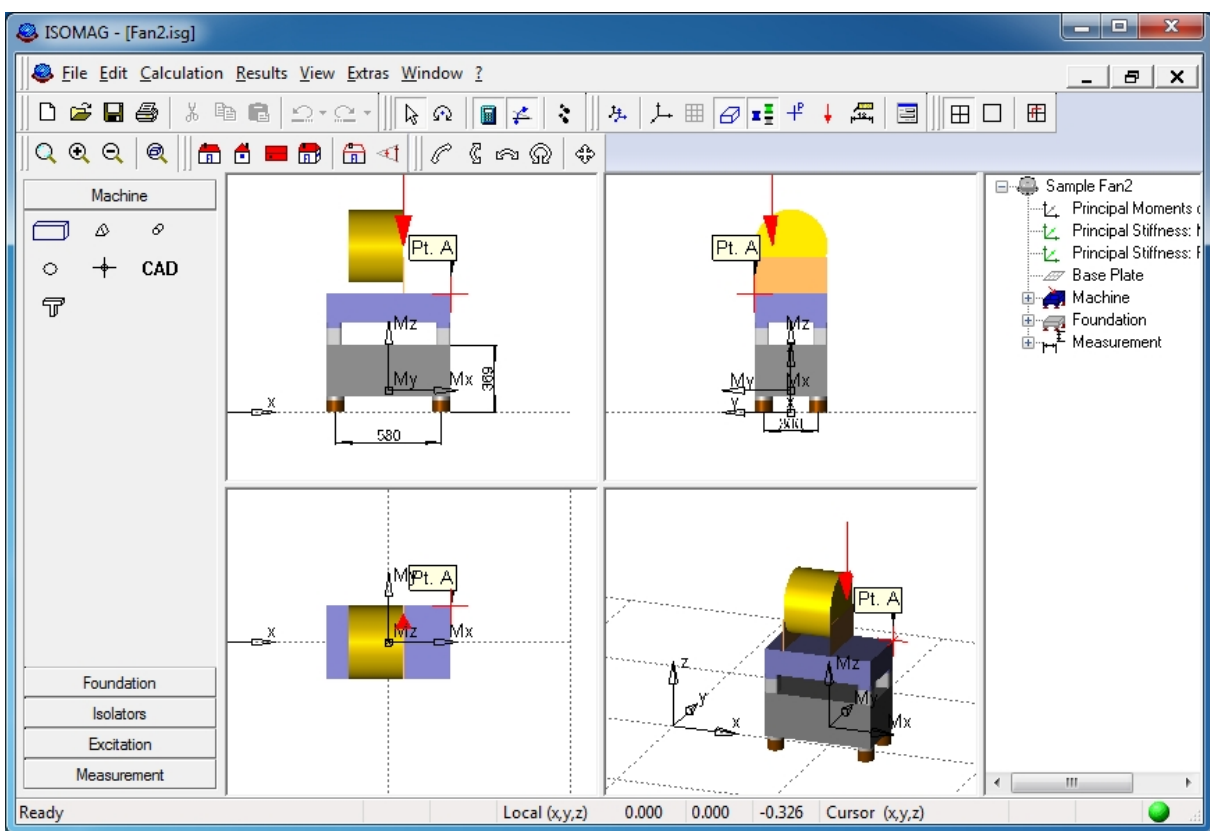

fig. 7.18 Example Fan2.isg

If a second excitation with 4 Hz is added to the above example Fan.isg, a degree of isolation of 80% cannot be achieved with the isolators available in the database. Therefore a double vibration isolation has to be applied. Based on the specification of the degree of isolation a suitable foundation is created using the wizard for double vibration isolation. Suitable isolators are selected from the database, and the machine is lifted up by the total height of the created foundation and the inserted isolators. At the same time the assignment of existing isolators is changed from "Machine – Ground" to "Machine - Foundation". Since with the suggested height of the foundation no suitable isolators can be found, the foundation thickness must be gradually increased, until for a thickness of 0.28 m a suitable isolator is found.

In the transmissibility (z-displacement of the point A) shown in **fig. 7.19** the desired degree of isolation is exceeded, between the two excitation frequencies, despite the compliance with the limits at the excitation frequencies themselves. The relation of maximum value of the dynamic displacement in z-direction to static displacement of the point A of 0,17 reaches the required degree of isolation.

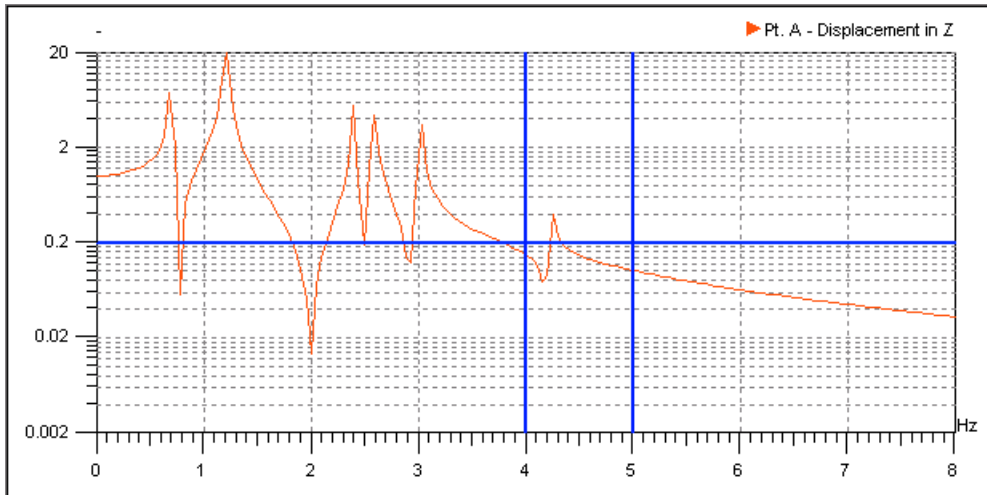

fig. 7.19 Fan2.isg: Transmissibility of displacement in z-direction of point A

7.4.4 Example Ground.isg

In this example the amplitudes of displacement, velocity, and acceleration at several points of a compressor foundation are calculated. The foundation is placed directly on the ground. The example was taken from [7] pp. 92. Sizes, positions and parameters of the items can be found in the example.

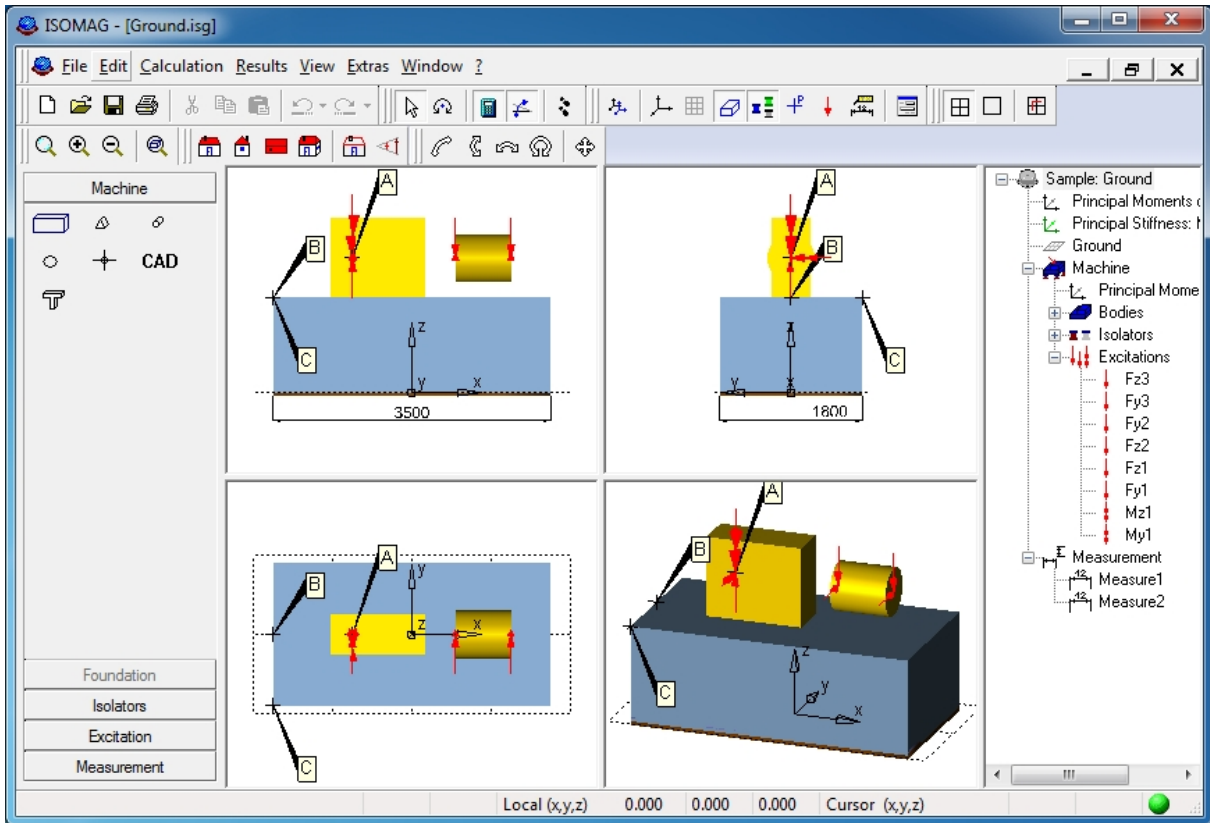

fig. 7.20 Example Ground.isg

The calculation of the stiffness and damping coefficients of the single spring representing the ground is shown in [4] section 2.7. It is essential in the creation of the spring that the elastic center of the spring coincides with the center of the area of the bottom surface. The external dimensions of the spring element do not play any role. In the example they were set to the foundation size only for visual reasons. As parameters the bedding number with $C = 120000 \text{ kN/m}^3$ and a damping coefficient with $\Phi = 0.007 \text{ s}$ were selected. In order to prevent settlement phenomena, the RMS of the velocity at the foundation base must not exceed 9 mm/s .

As excitations the forces of the compressor up to the second harmonic as well as the individual components of the imbalance forces of the drive motor are set. The natural frequencies as well as the maximum displacements at point A, the RMS of the acceleration at point B, and the RMS value of the velocity at C have to be calculated.

As excitation the forces of the compressor up to the second harmonic and the component of the imbalance forces of the motor are used. The eigenfrequencies, the maximum displacement of point A, the RMS values of the accelerations at point B and the RMS values of the velocity at point C are to be computed.

According to [27] the following results are expected:

- Displacement in A (max. values): $u_x=12.8 \mu\text{m}$, $u_y=14.8 \mu\text{m}$, $u_z= 21.4 \mu\text{m}$.
- Acceleration in B (RMS values): $a_x=0.08 \text{ m/s}^2$, $a_y=0.06 \text{ m/s}^2$, $a_z= 0.34 \text{ m/s}^2$
- Absolute value of the velocity in C: $v_c=2.37 \text{ mm/s}$.

We get essentially the same results as in [27]. Only the effective velocity is clearly smaller in [27] than in the **ISOMAG** simulation. This results from different definitions: In [27] the RMS of the speed is calculated by $v_{\text{eff}} = \omega \cdot \sqrt{(u_x^2 + u_y^2 + u_z^2) / 2}$. **ISOMAG** calculates the absolute value of the velocity vector $v(t) = (v_x(t), v_y(t), v_z(t))$, and treats it as a time function. The RMS of this function must be significantly larger than the value calculated with the definition from [27].

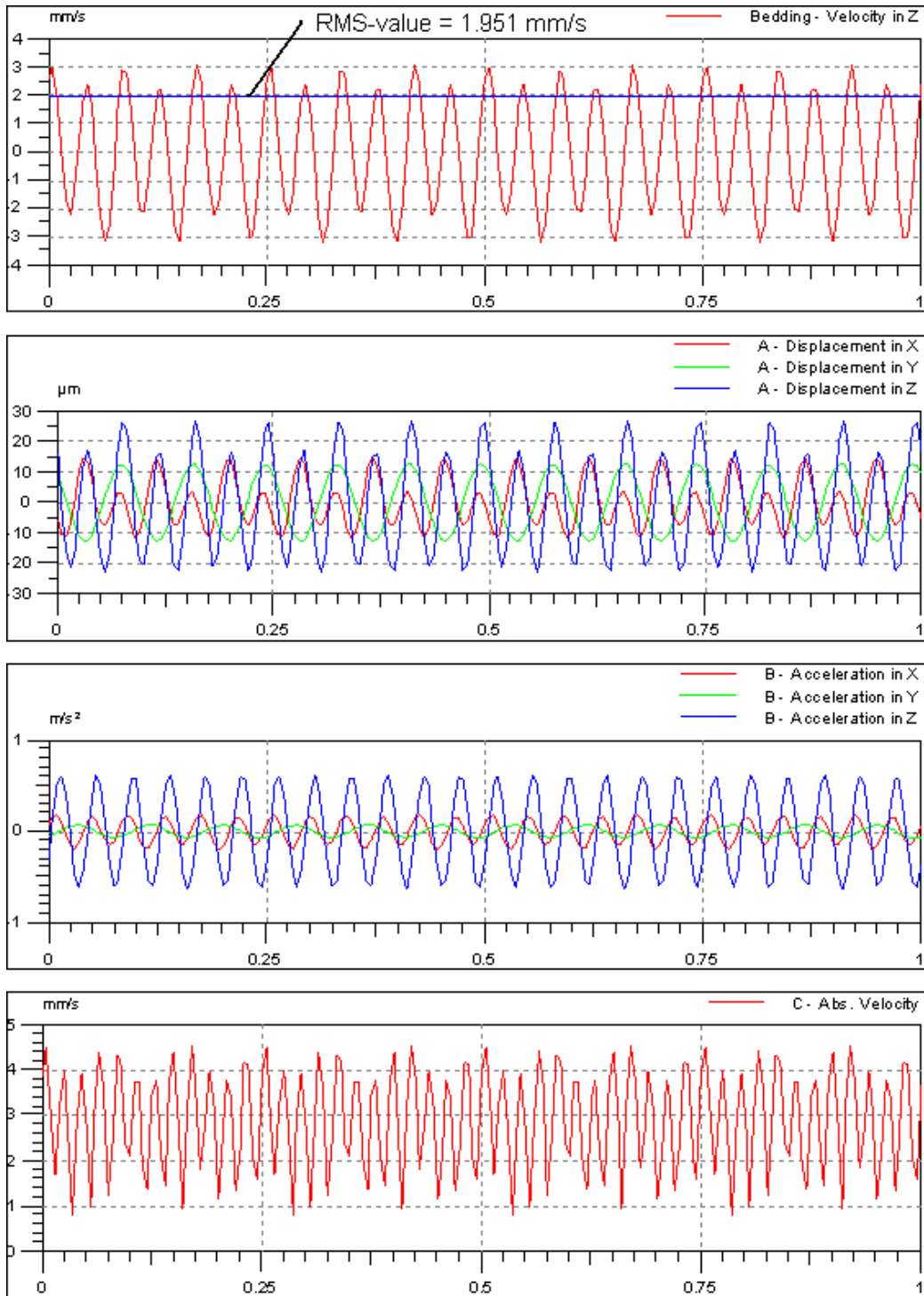

fig. 7.21 Results of the example Ground.isg